

Your Global Automation Partner

**TURCK**

# TB...-L...-FDIO1-2IOL

# Safety Block I/O Modules

Safety Manual — Translation

## Table of Contents

<b>1</b>	<b>About this manual</b> .....	<b>5</b>
1.1	Scope.....	5
1.2	Explanation of symbols used.....	5
1.3	Additional documents .....	6
<b>2</b>	<b>For your safety</b> .....	<b>7</b>
2.1	General safety notes.....	7
2.2	Residual risks (EN ISO 12100:2010) .....	7
2.3	Warranty and liability.....	7
2.4	Notes on explosion protection.....	8
2.5	Ex approval requirements for use in Ex area .....	8
<b>3</b>	<b>Safety Integrity Level/Performance Level/Category</b> .....	<b>9</b>
<b>4</b>	<b>Product Description</b> .....	<b>10</b>
4.1	Intended use .....	10
4.1.1	Reasonably foreseeable misuse .....	10
4.2	Device overview .....	11
4.2.1	Type label .....	13
4.3	Switches and connectors.....	14
4.4	Block diagram.....	16
<b>5</b>	<b>Safety function</b> .....	<b>17</b>
<b>6</b>	<b>Safety planning</b> .....	<b>18</b>
6.1	Prerequisites .....	18
6.2	Reaction time.....	18
6.3	Safety characteristic data .....	18
<b>7</b>	<b>Operating instructions</b> .....	<b>19</b>
7.1	Before operation .....	19
7.1.1	Mounting.....	20
7.1.2	Connecting .....	22
7.1.3	Addressing — TBPN-L...-FDIO1-2IOL .....	23
7.1.4	Addressing — TBIP-L...-FDIO1-2IOL .....	25
7.1.5	Web server login.....	28
7.1.6	Configuring.....	28
7.2	Operating .....	29
7.2.1	LED displays.....	29
7.2.2	Output error behavior .....	32
7.2.3	Decommissioning .....	32
<b>8</b>	<b>Appendix: wiring diagrams</b> .....	<b>33</b>
8.1	Ethernet .....	33
8.2	Power supply .....	33
8.3	Safety inputs (FDI) .....	34
8.4	Safety in-/outputs (FDX).....	34
8.5	DXP channels .....	35
8.6	IO-Link channels.....	35

9	Appendix: switching examples .....	36
9.1	Inputs .....	36
9.2	Outputs .....	37
10	Appendix: designations and abbreviations.....	38
11	Appendix: function tests .....	38
12	Appendix: document history .....	38
13	Appendix: technical data.....	39
13.1	Derating.....	41
14	Appendix: directives and standards.....	42
14.1	National and international directives and standards .....	42
14.2	Cited standards .....	42
15	Appendix: approvals and markings .....	43
16	Turck subsidiaries — contact information .....	44



# 1 About this manual

This safety manual contains all information that is required by users to operate the device in functional safety systems.

Read this manual carefully before using the device. This document addresses only functional safety according EN ISO 13849-1 and IEC 61508. Other issues are not considered.

All instructions must be followed in order to assure functional safety.

Always make sure that this is the latest version of the safety manual at [www.turck.com](http://www.turck.com). The German version is considered the definitive document. Every care was taken in the production of the translations of this document. If any uncertainties arise in the interpretation of the description, reference the German version of the Safety Manual or contact Turck.

## 1.1 Scope

This safety manual applies to the following Turck safety modules:

PROFIsafe module:

- TBPN-L1-FDIO1-2IOL
- TBPN-LL-FDIO1-2IOL

CIP Safety devices:

- TBIP-L4-FDIO1-2IOL
- TBIP-L5-FDIO1-2IOL
- TBIP-LL-FDIO1-2IOL

## 1.2 Explanation of symbols used

The following symbols are used in these instructions:



**DANGER**

DANGER indicates a dangerous situation with high risk of death or severe injury if not avoided.



**WARNING**

WARNING indicates a dangerous situation with medium risk of death or severe injury if not avoided.



**CAUTION**

CAUTION indicates a dangerous situation of medium risk which may result in minor or moderate injury if not avoided.



**NOTICE**

NOTICE indicates a situation which may lead to property damage if not avoided.



**NOTE**

NOTE indicates tips, recommendations and useful information on specific actions and facts. The notes simplify your work and help you to avoid additional work.



**CALL TO ACTION**

This symbol denotes actions that the user must carry out.



**RESULTS OF ACTION**

This symbol denotes relevant results of actions.

---

## 1.3 Additional documents

The following additional documents are available online at [www.turck.com](http://www.turck.com):

- Data sheet
- Declarations of conformity (current versions)
- Approvals
- Notes on Use in Ex zone 2 and 22 (100022986)

## 2 For your safety

The product is designed according to state-of-the-art technology. However, residual risks still exist. Observe the following warnings and safety notices to prevent damage to persons and property. Turck accepts no liability for damage caused by failure to observe these warning and safety notices.

### 2.1 General safety notes

- The device may only be assembled, installed, operated, parameterized and maintained by professionally-trained personnel.
- The device may only be used in accordance with applicable national and international regulations, standards and laws.
- The device meets the EMC requirements for industrial areas. When used in residential areas, take measures to avoid radio interference.
- The Performance Level as well as the safety category according to EN ISO 13849-1 depend on the external wiring, the application, the choice of the control devices as well as their arrangement on the machine.
- The user has to execute a risk assessment according to EN ISO 12100:2010.
- Based on the risk assessment a validation of the complete plant/machine has to be done in accordance with the relevant standards.
- Operating the device beyond the specification can lead to malfunctions or to the destruction of the device. The installation instructions must be observed.
- For trouble-free operation, the device must be properly transported, stored, installed and mounted.
- For the release of safety circuits in accordance with EN/IEC 60204-1, EN ISO/ISO 13850 only use the output circuits of connectors C2, C3, C4, C5 and C7 or respectively X2, X3, X4, X5 and X7.
- For connecting sensors and actuators in safety related applications only use the connectors C0...C3 or X0...X3.
- Change the default password of the integrated web server after the first login. Turck recommends using a secure password.

### 2.2 Residual risks (EN ISO 12100:2010)

The wiring proposals described in the following have been tested under operational conditions with the greatest care. Together with the connected periphery of safety related equipment and switching devices they fulfill relevant standards.

Residual risks remain, if

- the proposed wiring concept is changed and connected safety related devices or protective devices are possibly not or insufficiently included in the safety circuit.
- the operator does not observe the relevant safety regulations specified for the operation, adjustment and maintenance of the machine. Observe intervals for inspection and maintenance of the machine.

Failure to follow these instructions can result in serious injury or equipment damage.

### 2.3 Warranty and liability

Any warranty and liability is excluded for:

- Improper application or not intended use of the product
- Non-observance of the user manual
- Mounting, installation, configuration or commissioning by unqualified persons

## 2.4 Notes on explosion protection

- When operating the device in a hazardous area, the user must have a working knowledge of explosion protection (IEC/EN 60079-14, etc.).
- Observe national and international regulations for explosion protection.
- Only use the device within the permitted operating and ambient conditions (see Certification data and conditions resulting from the Ex-approval).

## 2.5 Ex approval requirements for use in Ex area

- Only use the device in an area with no more than pollution degree 2.
- Only disconnect and connect circuits when no voltage is applied.
- Only operate the switches if no voltage is present.
- Connect the metal protective cover to the equipotential bonding in the Ex area.
- Ensure impact resistance in accordance with EN IEC 60079-0 — alternative measures:
  - Install the device in the TB-SG-L protective housing (available in the set with Ultem window: ID 100014865) and replace the service window with an Ultem window.
  - Install the device in an area offering impact protection (e.g. in robot arm) and attach a warning: "DANGER: Only connect and disconnect circuits when no voltage is present. Do not operate switches when energized."
- Do not install the device in areas critically exposed to UV light.
- Prevent risks caused by electrostatic charge.
- Protect unused connectors with dummy plugs to ensure protection class IP67.



### 3 Safety Integrity Level/Performance Level/Category

The devices are rated for applications rated to:

- SIL3 according to EN 61508 and EN 62061
- Category 4/PLe according to EN ISO 13849-1

## 4 Product Description

The TBPN-L...-FDIO1-2IOL are safety block I/O modules for safety applications with PROFIsafe via PROFINET. The TBIP-L...-FDIO1-2IOL are a safety block I/O modules for safety applications using CIP Safety via EtherNet/IP.

The devices provide two SIL3-inputs (FDI) to connect 1- and 2-channel mechanical safety switches and electronic safety sensors (OSSD). Two further SIL3-channels (FDX) can be freely used as inputs (FDI) or outputs (FDO). The safety-related outputs are used for the safety-related disconnection of loads (resistive up to 2 A).

For non-safety relevant functions, the Safety Hybrid module has additional universal input channels as well as two IO-Link master channels for the connection of IO-Link sensors and IO-Link hubs for expansion to up to 32 I/O signals.

### 4.1 Intended use

The TB...-L...-FDIO1-2IOL are decentralized safety modules for PROFIsafe or CIP Safety.

The devices collect field signals and forward them safely to a PROFIsafe or CIP Safety master. Due to an extended temperature range from -40...+70 °C and IP67/IP69K protection the devices can be used directly on the machine demanding industrial environments.

The TB...-L...-FDIO1-2IOL are used for controlling signaling devices as for example emergency stop buttons, position switches or electro-sensitive protective equipment ESPEs which are used to ensure human, material or machine protection.

Digital sensors and actuators can be connected to the DXP channels. The two IO-Link master channels are used to connect IO-Link sensors and IO-Link hubs for expansion to up to 32 I/O signals.

The device is specified for the operation in industrial environment. If it is used in residential or mixing areas, radio interference may occur.

#### 4.1.1 Reasonably foreseeable misuse

The devices are not suitable for:

- Outdoor use
- The permanent use in liquids
- The use in Zone 0 and Zone 1

#### Modifications to the device

The device must not be modified either constructionally or technically.

## 4.2 Device overview

TBPN-L...-FDIO1-2IOL

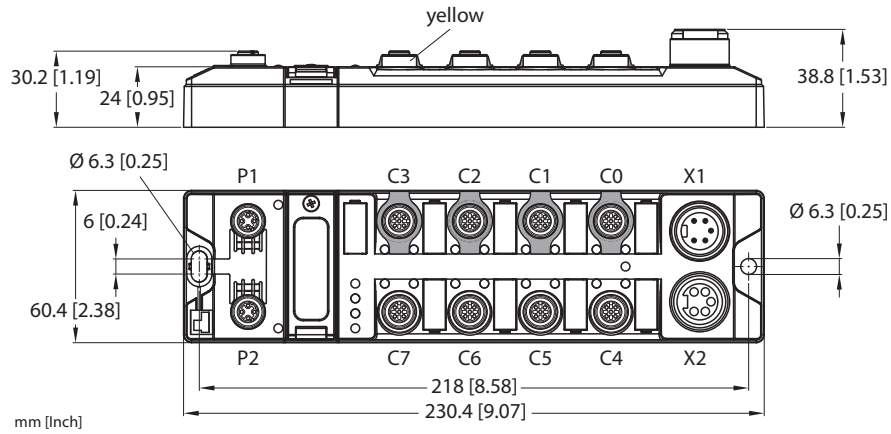

Fig. 1: TBPN-L1-FDIO1-2IOL

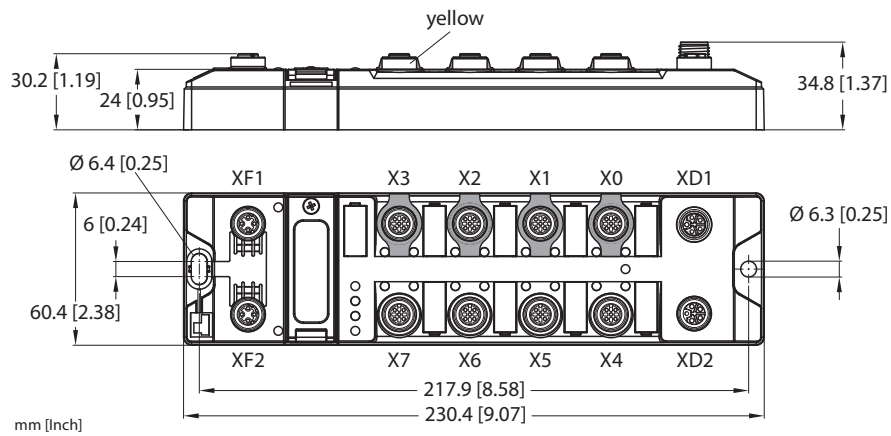

Fig. 2: TBPN-LL-FDIO1-2IOL

TBIP-L...-FDIO1-2IOL

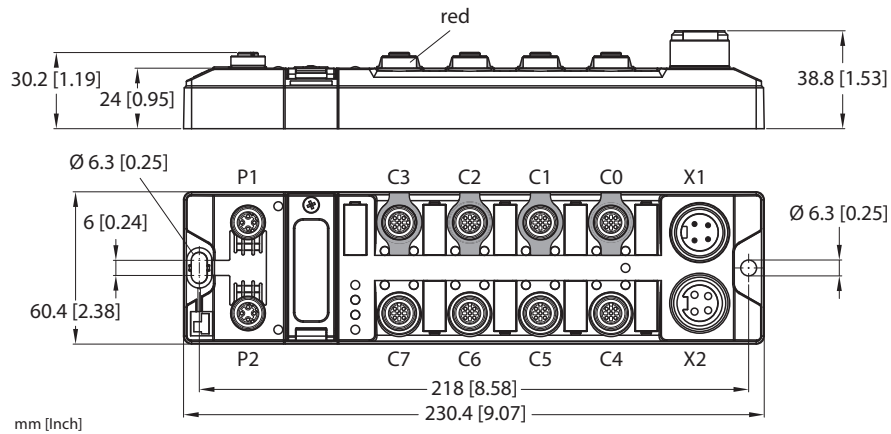

Fig. 3: TBIP-L4-FDIO1-2IOL

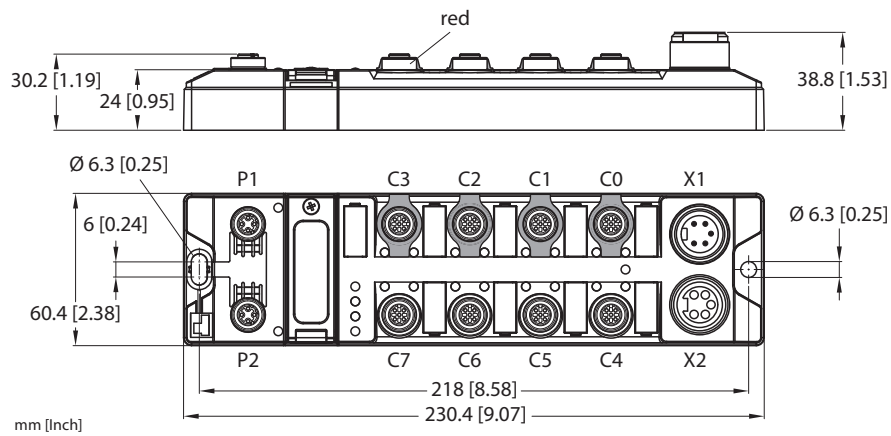

Fig. 4: TBIP-L5-FDIO1-2IOL

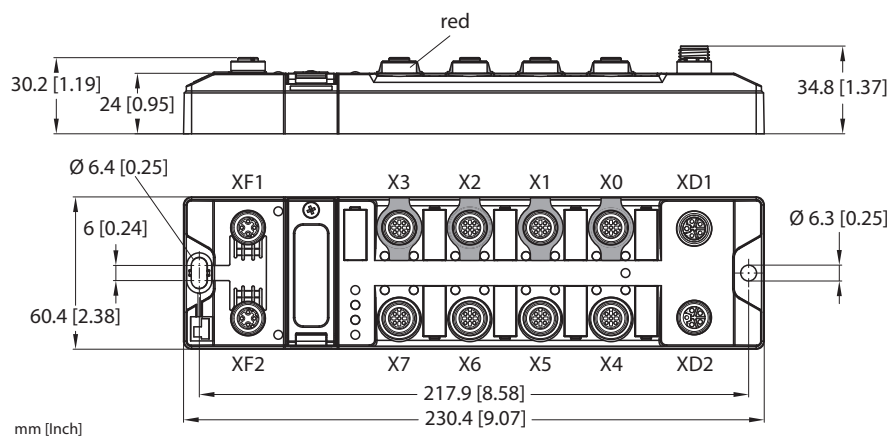

Fig. 5: TBIP-LL-FDIO1-2IOL

## 4.2.1 Type label

### TBPN-L1-FDIO1-2IOL

Ident-No.: 6814053 Hans Turck GmbH & Co. KG  
HW: D-45466 Mülheim a. d. Ruhr  
Charge code: www.turck.com  
YoC: Made in Germany

Fig. 6: Type label TBPN-L1-FDIO1-2IOL

### TBPN-LL-FDIO1-2IOL

Ident-No.: 100029879 Hans Turck GmbH & Co. KG  
HW: D-45466 Mülheim a. d. Ruhr  
Charge code: www.turck.com  
YoC: Made in Germany

Fig. 7: Type label TBPN-LL-FDIO1-2IOL

### TBIP-L4-FDIO1-2IOL

Ident-No.: 100000360 Hans Turck GmbH & Co. KG  
HW: D-45466 Mülheim a. d. Ruhr  
Charge code: www.turck.com  
YoC: Made in Germany

Fig. 8: Type label TBIP-L4-FDIO1-2IOL

### TBIP-L5-FDIO1-2IOL

Ident-No.: 6814056 Hans Turck GmbH & Co. KG  
HW: D-45466 Mülheim a. d. Ruhr  
Charge code: www.turck.com  
YoC: Made in Germany

Fig. 9: Type label TBIP-L5-FDIO1-2IOL

### TBIP-LL-FDIO1-2IOL

Ident-No.: 100027260 Hans Turck GmbH & Co. KG  
HW: D-45466 Mülheim a. d. Ruhr  
Charge code: www.turck.com  
YoC: Made in Germany

Fig. 10: Type label TBIP-LL-FDIO1-2IOL

## 4.3 Switches and connectors

### TBPN-L1-FDIO1-2IOL

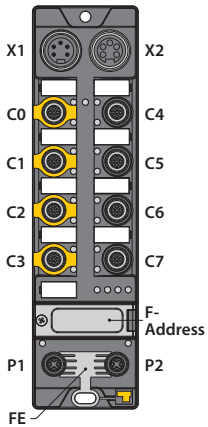
	Designation	Meaning
	X1	Power IN
	X2	Power OUT
	C0	FDI0/1, safety-related input
	C1	FDI2/3, safety-related input
	C2	FDX4/5, safety-related input
	C3	FDX6/7, safety-related input
	C4	DXP8/9, standard in-/outputs (safe shutdown via FSO0 possible)
	C5	DXP10/11, standard in-/outputs (safe shutdown via FSO0 possible)
	C6	IOL, IO-Link port 1
	C7	IOL, IO-Link port 2 (safe shutdown via FSO 1 possible)
	F-Address	Rotary coding switch for address setting for PROFIsafe (F-address setting)
	P1	Ethernet 1
	P2	Ethernet 2
	FE	Functional earth

### TBPN-LL-FDIO1-2IOL

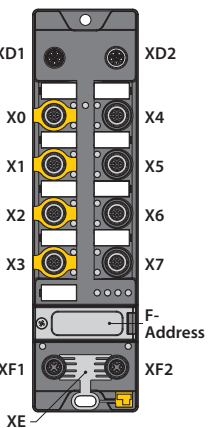
	Designation	Meaning
	XD1	Power IN
	XD2	Power OUT
	X0	FDI0/1, safety-related input
	X1	FDI2/3, safety-related input
	X2	FDX4/5, safety-related input
	X3	FDX6/7, safety-related input
	X4	DXP8/9, standard in-/outputs (safe shutdown via FSO0 possible)
	X5	DXP10/11, standard in-/outputs (safe shutdown via FSO0 possible)
	X6	IOL, IO-Link port 1
	X7	IOL, IO-Link port 2 (safe shutdown via FSO 1 possible)
	F-Address	Rotary coding switch for address setting for PROFIsafe (F-address setting)
	XF1	Ethernet 1
	XF2	Ethernet 2
	XE	Functional earth

TBIP-L4-FDIO1-2IOL/TBIP-L5FDIO1-2IOL

	Designation	Meaning
	X1	Power IN TBIP-L4-4FDI-4FDX: 4-pin TBIP-L5-4FDI-4FDX: 5-pin
	X2	Power OUT TBIP-L4-4FDI-4FDX: 4-pin TBIP-L5-4FDI-4FDX: 5-pin
	C0	FDI0/1, safety-related input
	C1	FDI2/3, safety-related input
	C2	FDX4/5, safety-related input
	C3	FDX6/7, safety-related input
	IP Address	Rotary coding switch for address setting (last byte of the IP address for the safe function unit)
	P1	Ethernet 1
	P2	Ethernet 2
	FE	Functional earth
	C4	DXP8/9, standard in-/outputs (safe shutdown via FSO0 possible)
	C5	DXP10/11, standard in-/outputs (safe shutdown via FSO0 possible)
	C6	IOL, IO-Link port 1
	C7	IOL, IO-Link port 2 (safe shutdown via FSO 1 possible)

TBIP-LL-FDIO1-2IOL

	Designation	Meaning
	XD1	Power IN
	XD2	Power OUT
	X0	FDI0/1, safety-related input
	X1	FDI2/3, safety-related input
	X2	FDX4/5, safety-related input
	X3	FDX6/7, safety-related input
	IP Address	Rotary coding switch for address setting (last byte of the IP address for the safe function unit)
	XF1	Ethernet 1
	XF2	Ethernet 2
	FE	Functional earth
	X4	DXP8/9, standard in-/outputs (safe shutdown via FSO0 possible)
	X5	DXP10/11, standard in-/outputs (safe shutdown via FSO0 possible)
	X6	IOL, IO-Link port 1
X7	IOL, IO-Link port 2 (safe shutdown via FSO 1 possible)	

#### 4.4 Block diagram

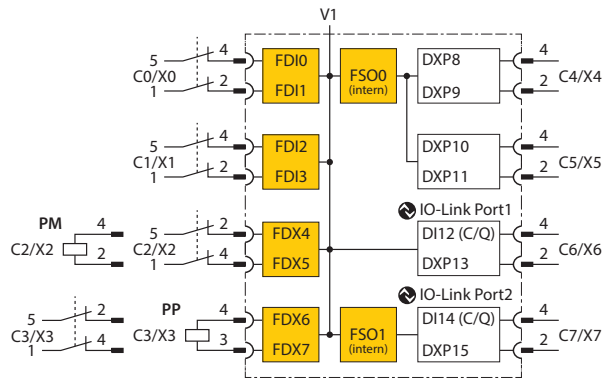

Fig. 11: Block diagram TBPN-L...-FDIO1-2IOL

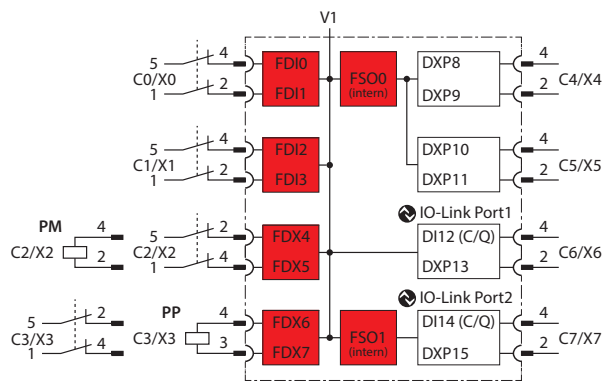

Fig. 12: Block diagram TBIP-L...-FDIO1-2IOL



## 5 Safety function

The TB...-L...-FDIO1-2IOL provide two safe digital SIL3 inputs (FDI) and two SIL3-connectors (FDX), configurable as in- or outputs.

The following devices can be connected to the safety inputs:

- 1- and 2-channel safety switches and sensors
- Contact based switches, e.g. emergency switches, protective door switches
- Sensors with OSSD switching outputs
- Antivalently switching OSSD sensors

The two safe SIL3 outputs can be used PP- or PM-switching.

### Safe Status

In the safe state the device outputs are in LOW-state (0). The inputs report a LOW-state (0) to the logic.

### Fatal Error

- Incorrect wiring at the output (i.e. capacitive load, energetic recovery)
- Short-circuit at the line control output T2
- Incorrect power supply
- Strong EMC disturbances
- Internal device error

## 6 Safety planning

The operator is responsible for the safety planning.

### 6.1 Prerequisites

- ▶ Perform a hazard and risk analysis.
- ▶ Develop a safety concept for the machine or plant.
- ▶ Calculate the safety integrity for the complete machine or plant.
- ▶ Validate the complete system.

### 6.2 Reaction time

If the device is operated with higher availability, the max. reaction time is extended (see "Safety Characteristic Data" [▶ 18]).

In addition to the reaction time in the device, reaction times of the further Safety components have to be system considered eventually. Please find the respective information in the technical data of the respective devices.

Further information about the reaction time can be found in the online help for the Turck Safety Configurator.

### 6.3 Safety characteristic data

Characteristic data	Value	Standard
Performance Level (PL)	e	EN/ISO 13849-1:2015
Safety category	4	
MTTF <sub>D</sub>	> 100 years (high)	
Permissible duration of use (TM)	20 years	
DC	99 %	
SIL (Safety Integrity Level)	3	EN 61508
PFH	$3.85 \times 10^{-9}$ 1/h	
Maximum on-time	12 months	
SIL CL	3	EN 62061:2005+
PFH <sub>D</sub>	$5.08 \times 10^{-9}$ 1/h	Cor.:2010+A1:2013+A2:2015
SFF	98.22 %	

Max. reaction time in case of shutdown	Value	Standard
<b>TBPN-L...-FDIO1-2IOL</b>		
PROFIsafe > local output	25 ms	EN 61508
Local input > PROFIsafe	20 ms	
Local input <> local output	35 ms	
<b>TBIP-L...-FDIO1-2IOL</b>		
CIP Safety > local output	25 ms	EN 61508
Local input > CIP Safety	20 ms	
Local input <> local output	35 ms	

## 7 Operating instructions

- ▶ In case of a safety application, register the devices under [www.turck.com/SIL](http://www.turck.com/SIL).
- ▶ Only allow trained and qualified personnel to assemble, install, commission and service the devices.
- ▶ The devices are not specified for a certain application. Make sure that application-specific aspects are considered.
- ▶ Replace the devices before the expiration of the permissible duration of use (see Safety Characteristic Data [▶ 18]).
- ▶ Execute a functional test every twelve months.
- ▶ Do not repair devices. If problems occur with regard to functional safety, Turck must be notified immediately and the devices must be returned immediately to:  
Hans Turck GmbH & Co. KG  
Witzlebenstraße 7  
45472 Mülheim an der Ruhr  
Germany
- ▶ In case of device errors which lead to the safe state, measures to be taken which guarantee the safe state for the further operation of the complete control system.
- ▶ Dangerous failures to be reported immediately to Turck.

### 7.1 Before operation

The operator of the machine or the plant in which the safety related system is used, is responsible for the correct and safe overall function of every single safety component.

- ▶ Carry out a validation of the safety category for the complete system depending on the selection of the used safety components.

## 7.1.1 Mounting

### Mounting the device in Zone 2 and Zone 22

In Zone 2 and Zone 22, the devices can be used in conjunction with the protective housing set TB-SG-L (ID 100014865).



#### **DANGER**

Potentially explosive atmosphere

**Risk of explosion through spark ignition**

**For use in Zone 2 and Zone 22:**

- ▶ Only install the device if there is no potentially explosive atmosphere present.
- ▶ Observe requirements for Ex approval.

- ▶ Unscrew the housing. Use Torx T8 screwdriver.
- ▶ Replace the service window with the enclosed Ultem window.
- ▶ Place the device on the base plate of the protective housing and fasten both together on the mounting plate [▶ 21].
- ▶ Connect the device [▶ 22].
- ▶ Mount and screw the housing cover according to the following figure. The tightening torque for the screws is 0.5 Nm.

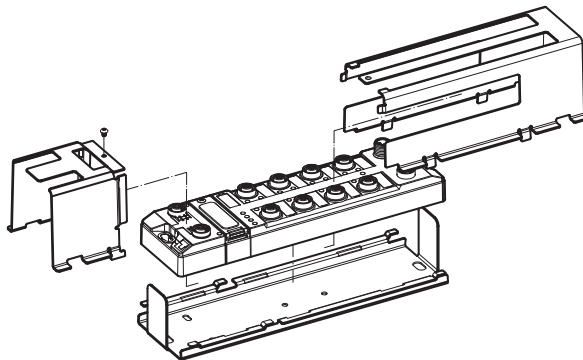

Fig. 13: Mounting the device in protection housing TB-SG-L

## Mounting onto a mounting plate



### NOTICE

Mounting on uneven surfaces

#### Device damage due to stresses in the housing

- ▶ Fix the device on a flat mounting surface.
- ▶ Use two M6 screws to mount the device.

The device can be screwed onto a flat mounting plate.

- ▶ Attach the module to the mounting surface with two M6 screws. The maximum tightening torque for the screws is 1.5 Nm.
- ▶ Avoid mechanical stresses.
- ▶ Optional: Ground the device.

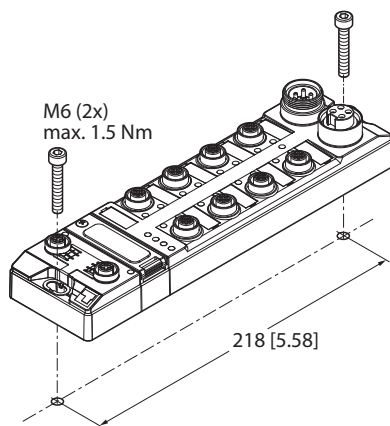

Fig. 14: Installing

## 7.1.2 Connecting

### Connecting the device in Zone 2 and Zone 22



#### **WARNING**

Intrusion of liquids or foreign bodies through leaking connections  
**Danger to life due to failure of the safety function**

- ▶ Tighten M12 connectors with a tightening torque of 0.6 Nm.
- ▶ Only use accessories that guarantee the protection class.
- ▶ Close unused M12 connectors with the supplied screw caps. The tightening torque for the screw caps is 0.5 Nm.
- ▶ Use appropriate 7/8" sealing caps, e.g. type RKMV-CCC. The caps not part of the scope of delivery.

### Connecting Ethernet

- ▶ Connect the device to Ethernet according to the pin assignment [▶ 33].

### Connecting the supply voltage

The externally connectable circuits have to be securely disconnected from the mains supply.



#### **WARNING**

Incorrect or defective power supply unit  
**Danger to life due to dangerous voltages on touchable parts**

- ▶ Only use for SELV or PELV power supplies in accordance with EN ISO 13849-2, which allow a maximum of 60 VDC or 25 VAC in the event of a fault.
- ▶ Connect the device to the power supply according to the pin assignment [▶ 33]. The female connectors at the device have the following function:  
X1 or XD1: Voltage IN  
X2 or XD2: Conduct voltage to next node

### Connecting sensors and actuators



#### **DANGER**

Wrong supply of sensors and actuators  
**Danger to life due to external supply**

- ▶ Exclude external supply.
- ▶ Guarantee that the inputs are only supplied through the same 24 V source as the device itself.
- ▶ Connect the sensors and actuators to the in- and outputs according to the respective pin assignment [▶ 33].



#### **DANGER**

Connection of fast reacting loads  
**Danger to life due to connection failures**

- ▶ Use loads with mechanical or electrical inertia. Positive and negative test pulses have to be tolerated.

### 7.1.3 Addressing — TBPN-L...-FDIO1-2IOL

#### Setting the F address via rotary coding switches

- ▶ Open the cover above the switches.
- ▶ Set the F address via the three rotary coding switches under the cover at device.
- ▶ Execute a power cycle.

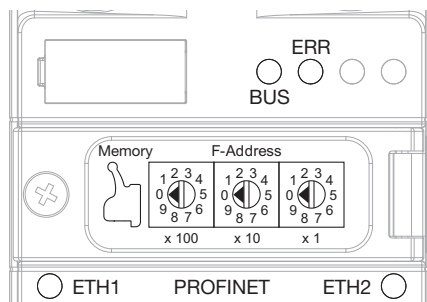

Fig. 15: Rotary coding switches at the device

In the delivery state, the rotary switches are set to 000 (0 - 0 - 0). Address 000 and addresses  $\geq 900$  are not valid F addresses.

Switch position	Meaning
000	Delivery state, no valid F-address
1...899	F address, accept setting by restarting the device
900	Factory Reset: Resets device to factory settings
901	Erase Memory: Deletes the content of the configuration memory

## Setting the IP address via the web server

To set the IP address via the web server, the device must be in PGM mode.

- ▶ Open the web server.
- ▶ Log on to the device as administrator. The default password for the web server is "password".



### NOTE

The password is transmitted in plain text.



### NOTICE

Inadequately secured devices

#### Unauthorized access to sensitive data

- ▶ Change password after first login. Turck recommends using a secure password.
  - ▶ Adapt the password to the requirements of the network security concept of the system in which the devices are installed.
- 
- ▶ Click **Station** → **Network Configuration**.
  - ▶ Change the IP address and, if necessary, the subnet mask and the default gateway.
  - ▶ Write the new IP address, the subnet mask and the default gateway via **Submit** into the device.

TURCK.COM For comments or questions, please email TURCK Support

**TURCK**

TBPN-L1-FDIO1-2IOL LOGOUT [ADMIN@192.168.1.47]

**STATION**

- Station Information
- Station Diagnostics
- Event Log
- Ethernet Statistics
- Links
- Station Configuration
- Network Configuration**
- Change Admin Password
- Safety Information
- Webserver Printf Log

**BASIC**

- SAFETY STATUS**
- IO-LINK PORT 1**
- IO-LINK PORT 2**
- DIAGNOSTICS**
- IO-LINK EVENTS**

**Network Configuration**

**Network Settings**

Ethernet Port 1 setup	Autonegotiate
Ethernet Port 2 setup	Autonegotiate
IP Address	192.168.1.2
Netmask	255.255.255.0
Default Gateway	0.0.0.0
MAC Address	00:07:46:08:59:0f
LLDP MAC Address 1	00:07:46:08:59:10
LLDP MAC Address 2	00:07:46:08:59:11

Submit Reset

Fig. 16: Webserver — Network configuration TBPN-L...-2FDIO-2IOL



### 7.1.4 Addressing — TBIP-L...-FDIO1-2IOL

The device supports two IP addresses. Whether the secondary IP address is required depends on the application and the CIP Safety Scanner used.

The first three bytes of the Main IP address can be set via the device's web server (IP address in delivery state: 192.168.1.254). The last byte of the IP address Main IP address can either be set via the rotary coding switches at the device, via the Turck Service Tool or via the web server.



**NOTE**

Turck recommends setting the IP address via the rotary coding switches (Static Rotary) on the device. The rotary mode supports easy device replacement.

- **Main IP Address:**  
IP address of the device to access the device with Turck Safety Configurator, PLC, web server, Turck Service Tool, etc.
- **Secondary IP Address:**  
depending on application possibly without function, must then be 0.0.0.0



**NOTE**

The Secondary IP address can only be set by using the web server of the device.

#### Setting the IP Address via rotary coding switches

- ▶ Open the cover above the switches.
- ▶ Set the last byte of the Main IP address via the three rotary coding switches under the cover at the device.
- ▶ Execute a power cycle.

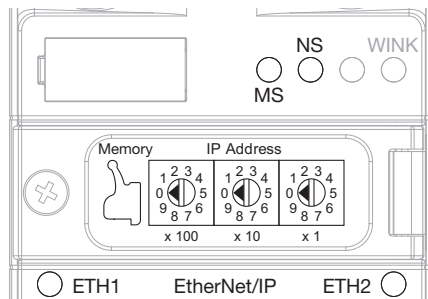

Fig. 17: Rotary coding switches at the device

In the delivery state, the rotary switches are set to 600 (6 - 0 - 0).

Switch position	Meaning
000	192.168.1.254
1...254	Rotary mode (Static rotary) Sets the last byte of the Main IP address, accept the setting with a device restart
300	BOOTP
400	DHCP
500	PGM
600	PGM-DHCP
900	Factory Reset: Resets device to factory settings
901	Erase Memory: Deletes the content of the memory chip

## Setting the IP address via the web server

To set the IP address via the web server, the device must be in PGM mode.

- ▶ Open the web server.
- ▶ Log on to the device as administrator. The default password for the web server is “password”.



### NOTE

The password is transmitted in plain text.



### NOTICE

Inadequately secured devices

#### Unauthorized access to sensitive data

- ▶ Change password after first login. Turck recommends using a secure password.
  - ▶ Adapt the password to the requirements of the network security concept of the system in which the devices are installed.
- 
- ▶ Click **Station** → **Network Configuration**.
  - ▶ Change the IP address and, if necessary, the subnet mask and the default gateway.
  - ▶ Write the new IP address, the subnet mask and the default gateway via **Submit** into the device.

**TBIP-L5-FDIO1-2IOL**  
Embedded Website of TBIP Safety Block I/O Module

admin@192.168.1.47 [Logout]

### Network Configuration >

- Station Information
- ! Station Diagnostics
- Event Log
- Ethernet Statistics
- EtherNet/IP™ Memory Map
- Links
- Station Configuration
- Network Configuration
- Change Admin Password
- Webserver Printf Log

---

- Basic
- Fieldbus Bits
- Safety status
- ! IO-Link Port 1
- IO-Link Port 2
- Diagnostics
- IO-Link Events

### Network Settings

Ethernet Port 1 setup	Autonegotiate ▾
Ethernet Port 2 setup	Autonegotiate ▾
Main IP Address	192.168.1 .100
Secondary IP Address	0.0.0.0
Netmask	255.255.255.0
Default Gateway	192.168.1.1
MAC Address	00:07:46:91:55:1c
SNN Number	ffff_ffff_ffff
SNN Decoded	<b>Invalid Value</b>

For comments or questions, please email [TURCK Support](mailto:TURCK Support)  
URL <http://www.turck.com> \* Revision V2.1.17.0

Fig. 18: Webserver — Network configuration TBIP-L...-2FDIO-2IOL

## Setting the Secondary IP Address via the web server

The Secondary IP Address is not used in the device and should always be set to 0.0.0.0.

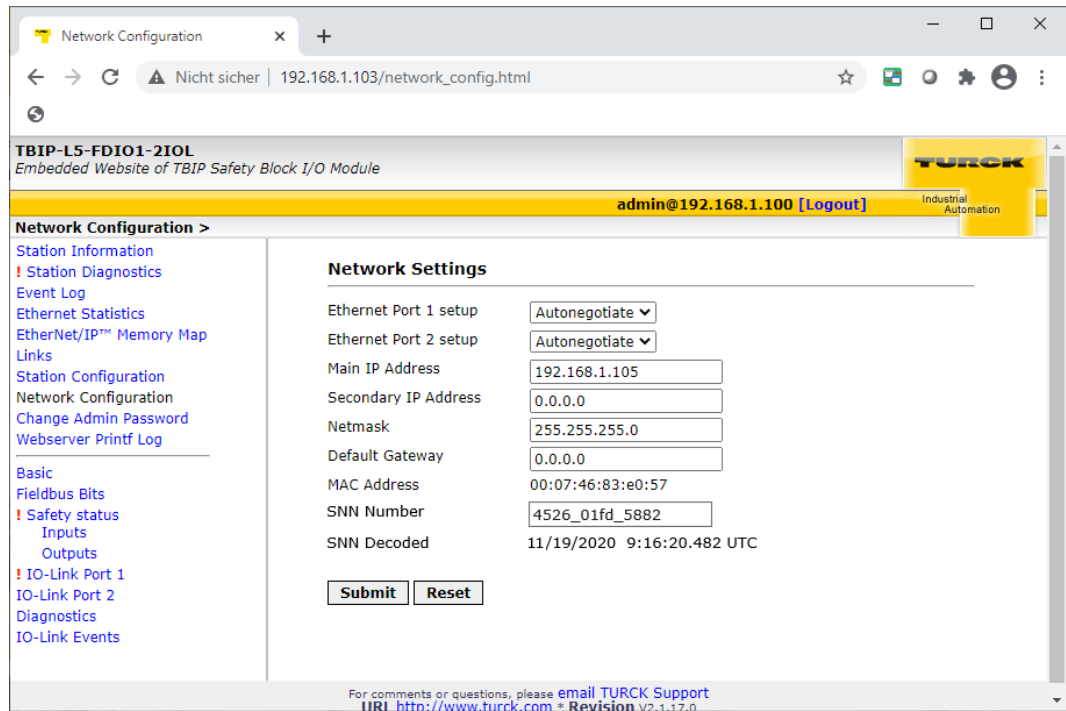

Fig. 19: Web server — setting the Secondary IP Address

### 7.1.5 Web server login

- ▶ Open the web server.
- ▶ Log on to the device as administrator. The default user for the web server is "admin", the default password is "password".
- ▶ Enter user name and password in the login field on the start page of the web server.
- ▶ Click **Login**.



#### **NOTE**

The password is transmitted in plain text.

---

### Secure device access with password



#### **NOTICE**

Inadequately secured devices

#### **Unauthorized access to sensitive data**

- ▶ Change password after first login. Turck recommends using a secure password.
  - ▶ Adapt the password to the requirements of the network security concept of the system in which the devices are installed.
- 

### 7.1.6 Configuring

The safety function of the safe channels can only be configured via the "Turck Safety Configurator" software.

After configuration, the device generates a configuration protocol including CRC (PROFIsafe) or a configuration signature and a time stamp (CIP Safety). The configuration protocol must be checked and confirmed by the user. The CRC or the Configuration Signature and the time stamp are stored in the configuration of the fail-safe controller as a reference and guarantee the correct safety function.

Further information on the Turck Safety Configurator software can be found in the online help.

The configuration of the safe I/O channels set via the Turck Safety Configurator is automatically stored on a plug-in memory chip (included in delivery). When a device is replaced, the device configuration can be transferred to another device using the memory chip.

## 7.2 Operating

### 7.2.1 LED displays

The device has the following LED indicators:

- Power supply
- Group and bus errors
- Status
- Diagnostics

LED PWR	Meaning
Off	No voltage connected or under voltage at V1
Green	Voltage V1 and V2 OK
Red	No valid state, device switches to the safe state
Red/green	No valid state, device switches to the safe state

LED 0...3 (C0...C1 or X0...X1)	Meaning
Off	Input active
Green	Input active
Green flashing	Self-test input
Red flashing	Cross Connection
Red	Discrepancy

LED 4...7 (C2...C3 or X2...X3)	Meaning	
	Channel is input	Channel is output
Off	Input active	Output inactive
Green	Input active	Output active
Green flashing	Self-test input	-
Red flashing	Cross Connection	-
red	Discrepancy	Overload

LED DXP 8...11 (C4...C5 or X4...X5)	Meaning (input)	Meaning (output)
	Off	Input inactive
Green	Input active	Output active
Green/red flashing	Input active, overload at supply	-
Red blinking	Input inactive, overload at supply	Overload of the supply voltage
Red	-	Output active with overload or short circuit

<b>LED IOL, LED 12 (C6/X6), LED 14 (C7/X7)</b>	<b>Meaning (Channel in IO-Link-mode)</b>
Off	Port inactive, no IO-Link communication, diagnostics deactivated
Green flashing	IO-Link communication, process data valid
Red flashing	IO-Link communication and module error, invalid process data
Red	IO-Link supply error free, no IO-Link communication and/ or module error, process data invalid

<b>LED IOL, LED 12 (C6/X6), LED 14 (C7/X7)</b>	<b>Meaning (channel in SIO mode (DI))</b>
Off	No input signal
Green	Digital input signal active

<b>LED DXP, LED 13 (C6/X6), LED 15 (C7/X7)</b>	<b>Meaning (input)</b>	<b>Meaning (output)</b>
Off	Input inactive	Output inactive
Green	Input active	Output active
Red	–	Output active with overload or short circuit

Note: The Ethernet ports P1 and P2 or XF1 and XF2 each have an LED ETH or L/A.

<b>LEDs ETH... or L/A</b>	<b>Meaning</b>
Off	No Ethernet connection
Green	Ethernet connection established, 100 Mbps
Green flashing	Ethernet traffic, 100 Mbps
Yellow	Ethernet connection established, 10 Mbps
Yellow blinking	Ethernet traffic, 10 Mbps

<b>LED WINK</b>	<b>Meaning</b>
White flashing	Helps to localize the module if the Blink/Wink command is active

<b>LED 0...7</b>	<b>Meaning</b>
Red blinking, all alternating	Fatal Error

TBPN-L...-FDIO1-2IOL

LED BUS	Meaning
Off	No voltage supply
Green	Active connection to a master
Green flashing	Device ready for operation
Red	IP address conflict, restore mode or F_reset active
Red flashing	Wink command active
Red/green, 1 Hz	Autonegotiation and/or waiting for DHCP-/BootP-address assignment

LED ERR	Meaning
Off	No voltage connected
Green	No diagnostics
Green flashing, 4 Hz	Initialization, configuration transfer from memory chip running
Red	Diagnostic message pending
Red/green	No valid state, device switches to the safe state

TBIP-L...-FDIO1-2IOL

LED MS	Meaning
Off	Device not powered
Green	No diagnostics, device is operating in normal condition
Green flashing	<ul style="list-style-type: none"> <li>■ Use with safety controller, device is EtherNet/IP server: Device is in the Idle or Standby State.</li> <li>■ Use without safety controller: Device is protected mode, an EtherNet/IP client is currently connected to the standard I/Os.</li> </ul>
Red	Critical fault: device has an unrecoverable fault Device replacement may be necessary.
Red flashing	Recoverable fault
Green flashing/red	<ul style="list-style-type: none"> <li>■ During start-up: device in self test</li> <li>■ During operation: device needs commissioning due to configuration or Unique Node Identifier missing, incomplete or incorrect</li> </ul>

LED NS	Meaning
Off	<ul style="list-style-type: none"> <li>■ Device is not on-line.</li> <li>■ Device not powered</li> </ul>
Green	Active connection to a master
Green flashing	<ul style="list-style-type: none"> <li>■ Device on-line but no connection</li> <li>■ A connection may be established, but not completed.</li> </ul>
Red	Communication error
Red flashing	One or more I/O connections are in the timed-out state.
Green/red flashing	<ul style="list-style-type: none"> <li>■ During start-up: device is in self test</li> <li>■ During operation: network access error detected, communication failed (Communication Faulted State)</li> </ul>

### 7.2.2 Output error behavior

In case of an error a switched-off output can be switched on for  $\leq 1$  ms.

### 7.2.3 Decommissioning

The decommissioning is described in the user manual.

- TBPN-L...-FDIO1-2IOL (D301378)
- TBIP-L...-FDIO1-2IOL (100000717)



## 8 Appendix: wiring diagrams

### 8.1 Ethernet

TBIP-L4-..., TBIP-L5-..., TBPN-L1-...

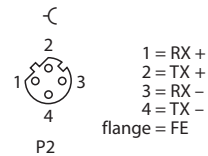
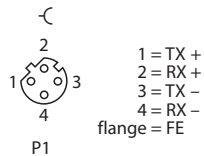

Fig. 20: Pin assignment Ethernet connector P1 Fig. 21: Pin assignment Ethernet connector P2

TB...-LL-...

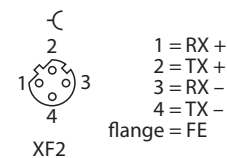
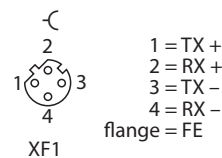

Fig. 22: Pin assignment Ethernet connector XF1

Fig. 23: Pin assignment Ethernet connector XF2

### 8.2 Power supply

TBPN-L1-...

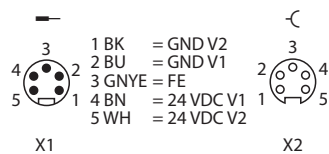

Fig. 24: Pin assignment voltage supply connectors, 7/8", 5-pin

TBIP-L4-...

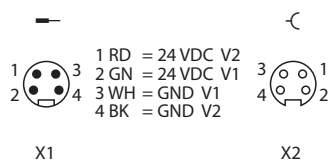

Fig. 25: Pin assignment voltage supply connectors, 7/8", 4-pin

TBIP-L5-...

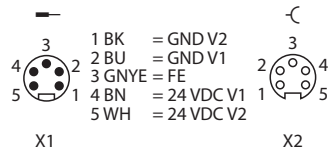

Fig. 26: Pin assignment voltage supply connectors, 7/8", 5-pin

TB...-LL-...

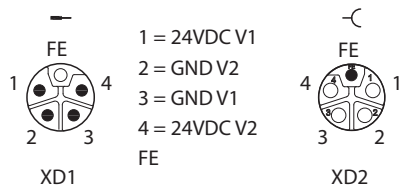

Fig. 27: Pin assignment voltage supply connectors, M12, 5-pin

### 8.3 Safety inputs (FDI)

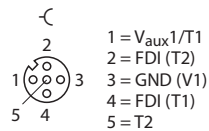

Fig. 28: Pin assignment FDI at C0...C1 or X0...X1

### 8.4 Safety in-/outputs (FDX)



#### NOTE

For PM-switching outputs, connect the negative pole of the load to the M-connector of the respective output (pin 2) [► 37].

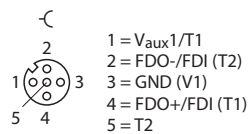

Fig. 29: Pin assignment FDX at C2...C3 or X2...X3

## 8.5 DXP channels

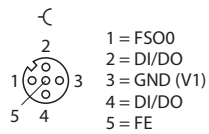

Fig. 30: Pin assignment C4...C5 or X4...X5

## 8.6 IO-Link channels

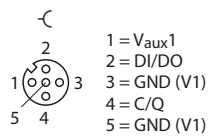

Fig. 31: Pin assignment IO-Link port IOL1 (C6 or X6)

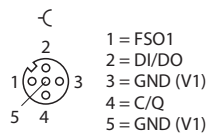
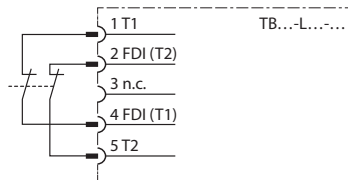

Fig. 32: Pin assignment IO-Link port IOL2 (C7 or X7)

## 9 Appendix: switching examples

### 9.1 Inputs

#### Safe equivalent input for potential-free contacts (normally closed/normally closed)



Connected in the switch

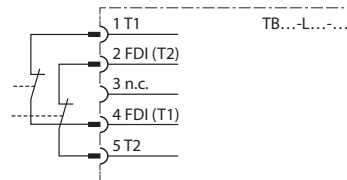

Two individual switches switching simultaneously via one application

#### Safe antivalent input for potential-free contacts (normally closed/normally closed)

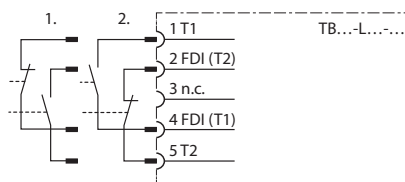

In the antivalent circuit, switches can be connected in different ways. The decisive factor for enabling is where the normally closed contact is connected.

- Example 1: The LEDs of the inputs are off when not actuated and light up when actuated. Use: e.g. for door monitoring with magnetic reed contacts
- Example 2: The LEDs of the inputs are off when actuated and light up when not actuated. Use: as programming for two-hand switches with two separate contacts

#### Safe electronic input (OSSD)

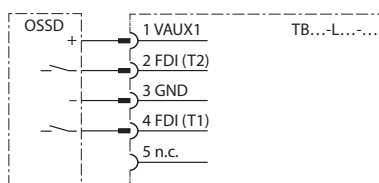

With this connection and corresponding parameterization, the pulsing of pins 1 and 5 is switched off. The supply voltage at pin 5 remains switched on.

Note:

- To avoid errors, do not use 5-pin cables to the sensor.

#### Safe electronic input (OSSD) antivalent switching

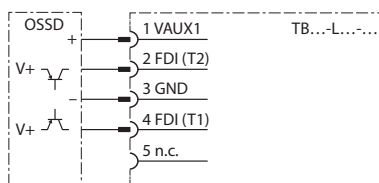

With this connection and corresponding parameterization, the pulsing of pins 1 and 5 is switched off. The supply voltage at pin 5 remains switched on. The NC contact is connected to pin 2 in order to receive a release when it is actuated. Connection example: Banner STB Touch

Note:

- To avoid errors, do not use 5-pin cables to the sensor.

**Safe inputs with single-channel mechanical contacts**

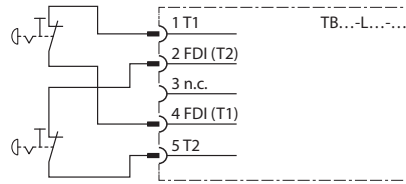

Inputs can be queried 1-channel.

- ▶ Connect sensors via two connection cables and a Y-plug (i.e. ID: 6634405) to the M12 sockets of the modules.

Note:

Changes to the preset properties of the inputs directly affect the performance level to be achieved. For more information, see the online help of the Turck Safety Configurator.

9.2 Outputs



**NOTE**

Any change in the test pulse interval of the outputs will change the performance level. The software and the online help of the software contain further information.

**Safe output PP-switching**

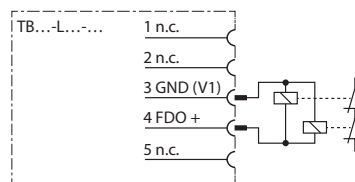

- ▶ For PP-switching outputs, connect the negative pole of the load to the GND connector of the respective output (pin 3).
- ▶ Do not connect the negative pole of the load to the ground of the power supply at a different location.
- ▶ The wiring has to allow an exclusion of faults (e.g. cross connection to external potential).

**Safe output PM switching**

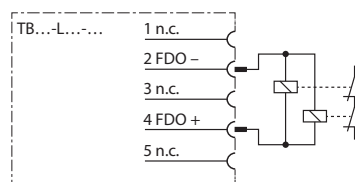

- ▶ For PM-switching outputs, connect the negative pole of the load to the M-connector of the respective output (pin 2).

## 10 Appendix: designations and abbreviations

Abbreviation	Meaning
DC	Diagnostic Coverage
HFT	Hardware failure tolerance
MTTF <sub>D</sub>	Mean Time To Failure Dangerous
PFD	Probability of dangerous failure on demand
PFH <sub>D</sub>	Average frequency of dangerous failure per hour
PL	Performance Level
SIL	Safety Integrity Level

## 11 Appendix: function tests

Ensure that the function test is only carried out by qualified personnel. A suggested function test consists of the following steps:

Step	Action
1	Switch every safety related input at least once a year.
2	Control the switching behavior by monitoring the output circuits.
3	Observe the maximum duty cycle and the total operation time depending on the selected PFD value.
4	If the maximum duty cycle is reached: Request the shutdown function in order to check the function of the safety system.

Once the test has been completed, document and archive the results.

## 12 Appendix: document history

Version	Date	Modifications
1.0	10/27/2017	First version
2.0	07/15/2022	Merged documentation of TBIP-L...FDIO1-2IOL and TBPN-L...-FDIO1-2IOL
		Chapter "For your safety" added
		Chapter "Obvious misuse" supplemented and renamed to "Reasonably foreseeable misuse" supplemented
		Use in Zone 2 added
		Safety characteristic data updated
		LL device variants added
		Chapter "Addressing" supplemented
		"Appendix: directives and standards" added
		"Appendix: approvals and markings" added
		Technical data supplemented

## 13 Appendix: technical data

<b>Devices</b>	
TBPN-L1-FDIO1-2IOL	
■ ID	6814053
■ YoC	According to device labeling
TBPN-LL-FDIO1-2IOL	
■ ID	100029879
■ YoC	According to device labeling
<b>Devices</b>	
TBIP-L5-FDIO1-2IOL	
■ ID	6814056
■ YoC	According to device labeling
TBIP-L4-FDIO1-2IOL	
■ ID	100000360
■ YoC	According to device labeling
TBIP-LL-FDIO1-2IOL	
■ ID	100027260
■ YoC	According to device labeling
<b>Power supply</b>	
V1 (incl. electronics supply)	24 VDC
V2	24 VDC, only through connected
Current feedthrough	
■ X1 to X1 (7/8")	9 A
■ XD1 tot XD2 (M12)	16 A
Permissible range	20.4...28.8 VDC
Total current	9 A
Isolation voltages	≥ 500 VAC
Connector	
■ TBPN-L1-FDIO1-2IOL	7/8", 5-pin
■ TBPN-LL-FDIO1-2IOL	M12, L coded, 5-pin
Connector	
■ TBIP-L5-FDIO1-2IOL	7/8", 5-pin
■ TBIP-L4-FDIO1-2IOL	7/8", 4-pin
■ TBIP-LL-FDIO1-2IOL	M12, L coded, 5-pin
<b>Interfaces</b>	
Ethernet	2 × M12, 4-pin, D coded
Service interface	Ethernet

**Safety inputs for potential free contacts**

Loop resistance	< 150 $\Omega$
Max. line capacity	max. 1 $\mu$ F at 150 $\Omega$ , limited by line capacity
Test pulse typ.	0.6 ms
Test pulse max.	0.8 ms
Sensor supply	Supply VAUX1/T1 max. 2 A, observe derating [▶ 41]
Interval between two test pulses, minimum	900 ms (for static inputs)
Connection to external potential	Not allowed

**Safety inputs for OSSD**

Signal voltage, low level	IEC 61131-2, type 1 (< 5 V; < 0,5 mA)
Signal voltage high level	IEC 61131-2, type 1 (< 15 V; < 2 mA)
Max. OSSD supply per channel	2 A per connector C0/X0...C7/X7 1.5 A at 70° C, observe derating [▶ 41]
Max. tolerated test pulse width	1 ms
Min. interval between two test pulses	12 ms at 1 ms test pulse width 8.5 ms at 0.5 ms test pulse width 7.5 ms at 0.2 ms test pulse width

**Safety outputs**

Suitable for inputs according to EN 61131-2, type 1	
Output level in OFF-state	< 5 V
Output level in OFF-state	< 1 mA
Test pulse resistive load, max.	0.5 ms
Test pulse, max.	1.25 ms
Interval between two test pulses, typical	500 ms
Interval between two test pulses, minimum	250 ms
Actuator supply	Supply VAUX1/T1 max. 2 A, observe derating [▶ 41]
Max. output current	2 A (resistive)
	1 A (inductive)
Max. total current for device	9 A
	Derating [▶ 41]
Max. output current	2 A (DC load)
	Derating [▶ 41]
The user have to provide an additional overcurrent protection on site.	

**Times**

Internal delay time (for calculating the watch-dog time)	10 ms
Response times	See Safety Characteristic Data [▶ 18]



General technical data	
Max. cable length	
■ Ethernet	100 m (per segment)
■ Sensor/actuator	30 m
Dimensions (W × L × H)	60.4 × 230.4 × 39 mm
Operating temperature	-40 °C... +70 °C
Storage temperature	-40 °C... +85 °C
Operating altitude	Max. 5000 m
Protection class	IP65 IP67 IP69K The degree of protection is only guaranteed if unused connections are closed with suitable screw caps or blind caps.
Housing material	Fibre-glass reinforced Polyamide (PA6-GF30)
Housing color	black
Material connectors	brass, nickel-plated
Window material	Lexan
Material screw	303 stainless steel
Material label	Polycarbonate
Halogen-free	Yes
Mounting	2 mounting holes, Ø 6,3 mm
Tests	
Vibration test	According to IEC 60068-2-6, IEC 60068-2-47, acceleration up to 20 g
Drop and topple	According to IEC 60068-2-31/IEC 60068-2-32
Shock test	According to IEC 60068-2-27
Electro magnetic compatibility	According to IEC 61131-2/IEC 61326-3-1

### 13.1 Derating

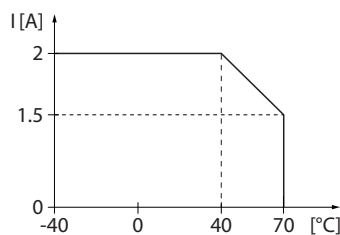

Fig. 33: Derating – output current

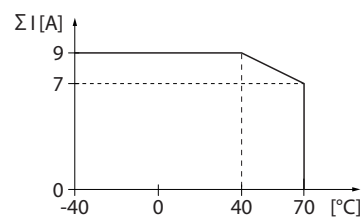

Fig. 34: Derating – total current

## 14 Appendix: directives and standards

### 14.1 National and international directives and standards

The following guidelines and regulations must be observed:

- 2006/42/EG (machine directive), SI 2008/1597
- 2014/34/EU (electromagnetic compatibility), SI 2016/1091
- 2014/34/EU (ATEX directive), SI 2016/1107
- 2011/65/EU (RoHS-Directive), SI 2012/3032
- 89/655/EEG (work equipment directive)
- Accident prevention regulation
- Safety rules and safety regulations according to the actual state of the art

### 14.2 Cited standards

Standard	Title
DIN EN ISO 13849-1:2016-06	Safety-related parts of control systems
EN 62061:2005 + Cor.:2010 + A1:2013 + A2:2015 IEC 62061:2005 + A1:2012 + A2:2015	Safety of machinery - Functional safety of safety-related electrical, electronic and programmable electronic control systems
DIN EN 61508:2011 IEC 61508:2010	Functional safety of electrical/electronic/programmable electronic safety-related systems
DIN EN 61131-2:2008 IEC 61131-2:2007	Programmable controllers
EN ISO 12100:2010 DIN EN ISO 12100:211-03	Safety of machinery - General principles for design - Risk assessment and risk reduction

## 15 Appendix: approvals and markings

Approvals	Marking according to ATEX directive UKSI (SI 2016/1107)	EN 60079-0/-7/-31
ATEX approval no.: TÜV 20 ATEX 264795 X UKEX approval no.: TURCK Ex-20002HX	⊕ II 3 G ⊕ II 3 D	Ex ec IIC T4 Gc Ex tc IIIC T115 °C Dc
IECEx approval no.: IECEx TUN 20.0010X		Ex ec IIC T4 Gc Ex tc IIIC T115 °C Dc

Ambient temperature  $T_{amb.}$ : -25 °C...+60 °C

Type designation	TB...-L...-FDIO1-2IOL
Power supply	24 VDC ±10 % (SELV/PELV)
Input current $I_{max}$	9 A (total per module)
Output current $I_{max}$	1,5 A (per output)

## 16 Turck subsidiaries — contact information

<b>Germany</b>	Hans Turck GmbH & Co. KG Witzlebenstraße 7, 45472 Mülheim an der Ruhr <a href="http://www.turck.de">www.turck.de</a>
<b>Australia</b>	Turck Australia Pty Ltd Building 4, 19-25 Duerdin Street, Notting Hill, 3168 Victoria <a href="http://www.turck.com.au">www.turck.com.au</a>
<b>Belgium</b>	TURCK MULTIPROX Lion d'Orweg 12, B-9300 Aalst <a href="http://www.multiprox.be">www.multiprox.be</a>
<b>Brazil</b>	Turck do Brasil Automação Ltda. Rua Anjo Custódio Nr. 42, Jardim Anália Franco, CEP 03358-040 São Paulo <a href="http://www.turck.com.br">www.turck.com.br</a>
<b>China</b>	Turck (Tianjin) Sensor Co. Ltd. 18,4th Xinghuazhi Road, Xiqing Economic Development Area, 300381 Tianjin <a href="http://www.turck.com.cn">www.turck.com.cn</a>
<b>France</b>	TURCK BANNER S.A.S. 11 rue de Courtalin Bat C, Magny Le Hongre, F-77703 MARNE LA VALLEE Cedex 4 <a href="http://www.turckbanner.fr">www.turckbanner.fr</a>
<b>Great Britain</b>	TURCK BANNER LIMITED Blenheim House, Hurricane Way, GB-SS11 8YT Wickford, Essex <a href="http://www.turckbanner.co.uk">www.turckbanner.co.uk</a>
<b>India</b>	TURCK India Automation Pvt. Ltd. 401-403 Aurum Avenue, Survey. No 109 /4, Near Cummins Complex, Baner-Balewadi Link Rd., 411045 Pune - Maharashtra <a href="http://www.turck.co.in">www.turck.co.in</a>
<b>Italy</b>	TURCK BANNER S.R.L. Via San Domenico 5, IT-20008 Bareggio (MI) <a href="http://www.turckbanner.it">www.turckbanner.it</a>
<b>Japan</b>	TURCK Japan Corporation Syuuhou Bldg. 6F, 2-13-12, Kanda-Sudacho, Chiyoda-ku, 101-0041 Tokyo <a href="http://www.turck.jp">www.turck.jp</a>
<b>Canada</b>	Turck Canada Inc. 140 Duffield Drive, CDN-Markham, Ontario L6G 1B5 <a href="http://www.turck.ca">www.turck.ca</a>
<b>Korea</b>	Turck Korea Co, Ltd. B-509 Gwangmyeong Technopark, 60 Haan-ro, Gwangmyeong-si, 14322 Gyeonggi-Do <a href="http://www.turck.kr">www.turck.kr</a>
<b>Malaysia</b>	Turck Banner Malaysia Sdn Bhd Unit A-23A-08, Tower A, Pinnacle Petaling Jaya, Jalan Utara C, 46200 Petaling Jaya Selangor <a href="http://www.turckbanner.my">www.turckbanner.my</a>

<b>Mexico</b>	Turck Comercial, S. de RL de CV Blvd. Campestre No. 100, Parque Industrial SERVER, C.P. 25350 Arteaga, Coahuila <a href="http://www.turck.com.mx">www.turck.com.mx</a>
<b>Netherlands</b>	Turck B. V. Ruiterlaan 7, NL-8019 BN Zwolle <a href="http://www.turck.nl">www.turck.nl</a>
<b>Austria</b>	Turck GmbH Graumanngasse 7/A5-1, A-1150 Wien <a href="http://www.turck.at">www.turck.at</a>
<b>Poland</b>	TURCK sp.z.o.o. Wroclawska 115, PL-45-836 Opole <a href="http://www.turck.pl">www.turck.pl</a>
<b>Romania</b>	Turck Automation Romania SRL Str. Siriului nr. 6-8, Sector 1, RO-014354 Bucuresti <a href="http://www.turck.ro">www.turck.ro</a>
<b>Russian Federation</b>	TURCK RUS OOO 2-nd Pryadilnaya Street, 1, 105037 Moscow <a href="http://www.turck.ru">www.turck.ru</a>
<b>Sweden</b>	Turck Sweden Office Fabriksstråket 9, 433 76 Jonsered <a href="http://www.turck.se">www.turck.se</a>
<b>Singapore</b>	TURCK BANNER Singapore Pte. Ltd. 25 International Business Park, #04-75/77 (West Wing) German Centre, 609916 Singapore <a href="http://www.turckbanner.sg">www.turckbanner.sg</a>
<b>South Africa</b>	Turck Banner (Pty) Ltd Boeing Road East, Bedfordview, ZA-2007 Johannesburg <a href="http://www.turckbanner.co.za">www.turckbanner.co.za</a>
<b>Czech Republic</b>	TURCK s.r.o. Na Brne 2065, CZ-500 06 Hradec Králové <a href="http://www.turck.cz">www.turck.cz</a>
<b>Turkey</b>	Turck Otomasyon Ticaret Limited Sirketi Inönü mah. Kayisdagi c., Yesil Konak Evleri No: 178, A Blok D:4, 34755 Kadiköy/ Istanbul <a href="http://www.turck.com.tr">www.turck.com.tr</a>
<b>Hungary</b>	TURCK Hungary kft. Árpád fejedelem útja 26-28., Óbuda Gate, 2. em., H-1023 Budapest <a href="http://www.turck.hu">www.turck.hu</a>
<b>USA</b>	Turck Inc. 3000 Campus Drive, USA-MN 55441 Minneapolis <a href="http://www.turck.us">www.turck.us</a>

# TURCK

Over 30 subsidiaries and  
60 representations worldwide!

10000664 | 2022/07



[www.turck.com](http://www.turck.com)