

REI-05IA0E-4A200-H1181

Incremental Encoder

Industrial Line

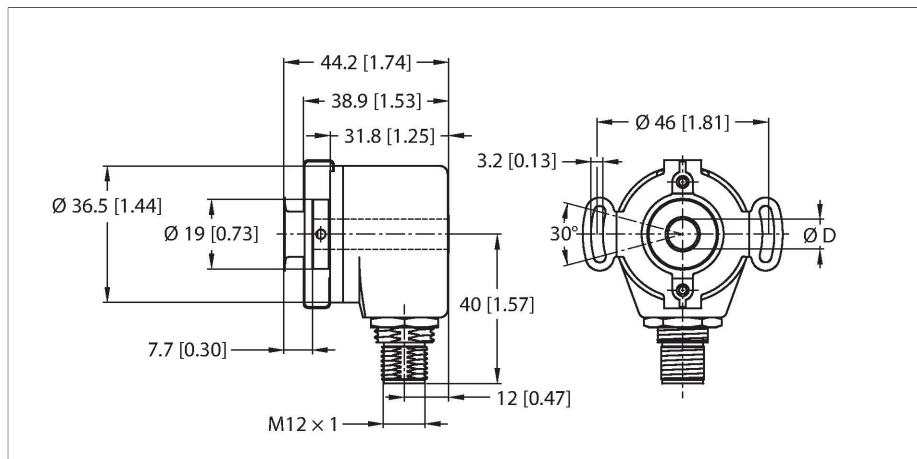

Features

- Flange with stator coupling, Ø 46 mm
- Hollow shaft, Ø 1/8"
- Optical measuring principle
- Shaft material: brass
- Protection class shaft IP50
- Protection class housing IP65
- -20...+85 °C
- Max. 6000 rpm
- 5 VDC
- RS422/TTL invertible
- Pulse frequency max. 200 kHz
- M12 × 1 male connector, 8-pin
- 200 pulses per revolution

Technical data

Type	REI-05IA0E-4A200-H1181
ID	100011226
Measuring principle	Optical
General data	
Max. rotational speed	6000 rpm
Moment of inertia of the rotor	$0.2 \times 10^{-5} \text{ kgm}^2$
Starting torque	< 0.05 Nm
Output type	Incremental
Resolution incremental	200 ppr
Electrical data	
Operating voltage U_B	5 VDC
No-load current	≤ 90 mA
Output current	≤ 20 mA
Short-circuit protection	yes
Pulse frequency max.	200 kHz
Signal level high	min. 2.5 V
Signal level low	max. 0.5 V
Output function	RS422, invertible
Mechanical data	
Flange type	Flange with stator coupling
Flange diameter	Ø 46 mm
Shaft Type	Hollow shaft
Shaft diameter D (mm)	6.35
Shaft diameter D	0.25 in
	Hollow shaft
Shaft material	Brass

Wiring diagram

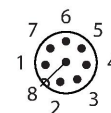
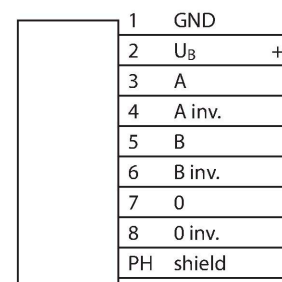

Technical data

Housing material	Aluminum chromated
Electrical connection	Connector, M12 × 1
	8-polig
Axial shaft load	20 N
Radial shaft load	40 N
Environmental conditions	
Ambient temperature	-20...+85 °C
Vibration resistance (EN 60068-2-6)	100 m/s ² , 55...2000 Hz
Shock resistance (EN 60068-2-27)	1000 m/s ² , 6 ms
Protection class	IP65
Protection class shaft	IP50

Accessories

RME-3

1544614

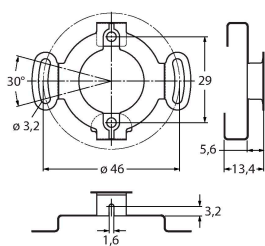

Stainless steel stator coupling for hollow shaft encoders, reference diameter 46 mm, for highly dynamic applications with axial and radial play

RME-13

1544624

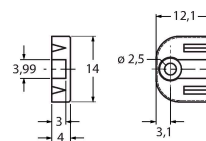

Plastic mounting element for hollow shaft encoders, pitch diameter 42 mm, for applications with limited axial play, low dynamics and limited mounting space

RME-14

1544625

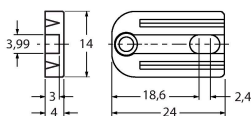

Plastic mounting element for hollow shaft encoders, pitch diameters 44 mm, 60 mm, 63 mm, 65 mm, for low dynamic applications with high axial play.

Accessories

Dimension drawing	Type	ID	
	RKC8T-2/TXL	6625142	Connection cable, M12 female connector, straight, 8-pin, cable length: 2 m, jacket material: PUR, black; cULus approval

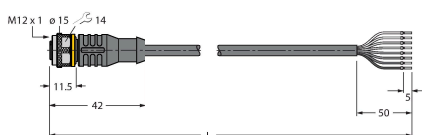

Dimension drawing

Type

WKC8T-2/TXL

ID

6625145

Connection cable, M12 female connector, angled, 8-pin, cable length: 2 m, jacket material: PUR, black; cULus approval

