

RA1-EQR24

Accessories – Adapter Sleeve

For Encoders RI-QR24

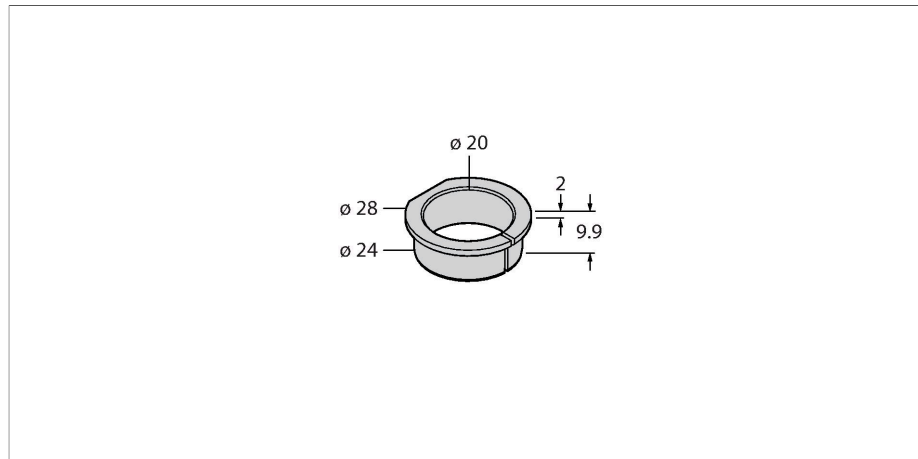

Features

- Adapter sleeve 20 mm
- Stainless steel: 1.4404 V4A

Technical data

Type	RA1-EQR24
Ident. no.	1593019
Housing material	Stainless steel, V4A 1.4404 (AISI 316L)