

# RU200-CK40-2UP8X2T-H1151

## Ultrasonic Sensor – Diffuse Mode Sensor

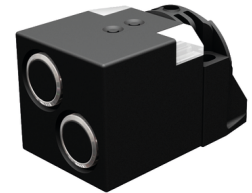
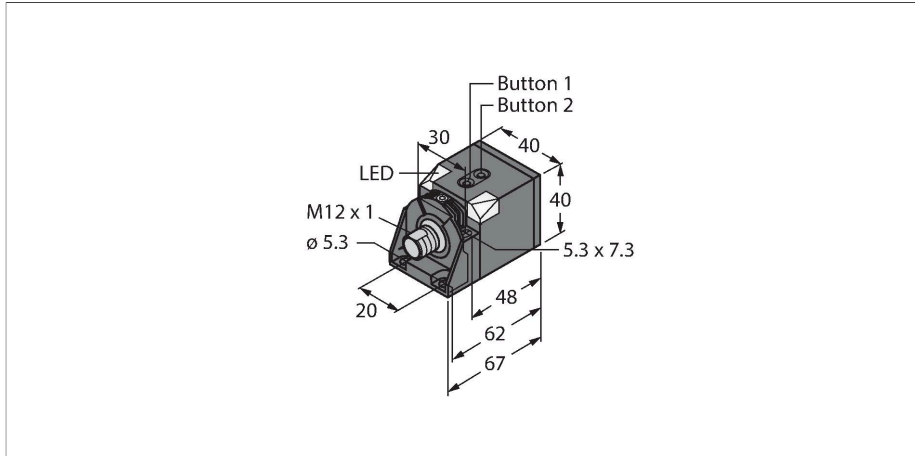

### Technical data

Type	RU200-CK40-2UP8X2T-H1151
ID	1610051
<b>Ultrasonic data</b>	
Function	Proximity switch
Range	50...2000 mm
Resolution	1 mm
Minimum switching range	20 mm
Ultrasound frequency	120 kHz
Repeat accuracy	≤ 0.25 % of full scale
Edge lengths of the nominal actuator	100 mm
Approach speed	≤ 3 m/s
Pass speed	≤ 3 m/s
<b>Electrical data</b>	
Operating voltage $U_b$	15...30 VDC
Residual ripple	10 % $U_{ss}$
DC rated operating current $I_o$	≤ 150 mA
No-load current	≤ 50 mA
Load resistance	≤ 1000 $\Omega$
Residual current	≤ 0.1 mA
Response time typical	< 160 ms
Readiness delay	≤ 300 ms
Output function	NO/NC, PNP
Output 1	Switching output
Output 2	Switching output
Switching frequency	≤ 3 Hz
Hysteresis	≤ 20 mm
Voltage drop at $I_o$	≤ 2.5 V

### Features

- Separate transducers for transmitter and receiver
- Rectangular housing 40 x 40 mm
- Connection via M12 x 1 male
- Teach range adjustable via button
- Blind zone: 5 cm
- Range: 200 cm
- Resolution: 1 mm
- Aperture angle of sonic cone:  $\pm 60^\circ$
- 2 x switching outputs, PNP
- NO/NC programmable

### Wiring diagram

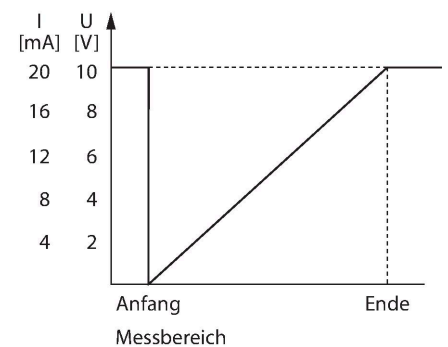
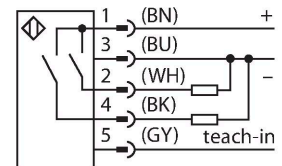

## Technical data

Short-circuit protection	yes/Latching
Reverse polarity protection	yes
Wire breakage protection	yes
Setting option	Remote Teach
<b>Mechanical data</b>	
Design	Rectangular, CK40
Radiation direction	straight
Dimensions	67 x 40 x 40 mm
Housing material	Plastic, PBT-GF30-V0
Electrical connection	Connector, M12 x 1, 5-wire
Ambient temperature	0...+70 °C
Pressure resistance	0.5...5 bar
Protection class	IP40
Switching state	LED, Yellow
Object detected	LED, Green
<b>Tests/approvals</b>	
Declaration of conformity EN ISO/IEC	EN 60947-5-2
Vibration resistance	20 g, 10...55 Hz, sine, 3 axes, 30 min/axis according to IEC 60068-2-6
Shock test	30 g, 11 ms, half sine, 3 axes according to IEC 60068-2-27
Approvals	CE cULus

## Functional principle

Ultrasonic sensors capture a multitude of objects contactlessly and wear-free with ultrasonic waves. It does not matter whether the object is transparent or opaque, metallic or non-metallic, firm, liquid or powdery. Even environmental conditions such as spray, dust or rain hardly affect their function.

The sonic cone diagram indicates the detection range of the sensor. In accordance with standard EN 60947-5-2, quadratic targets in a range of sizes (20 x 20 mm, 100 x 100 mm) and a round rod with a diameter of 27 mm are used.

Important: The detection ranges for other targets may differ from those for standard targets due to the different reflection properties and geometries.

## Sonic Cone

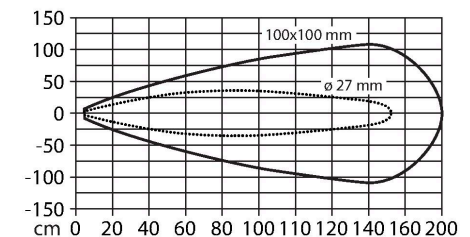

## Output behaviour

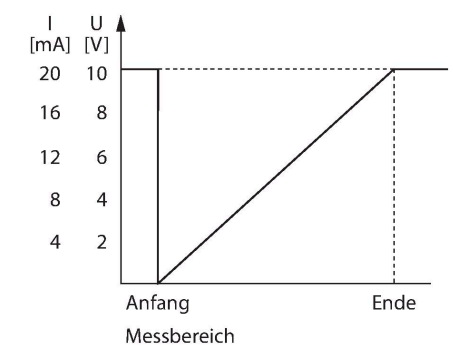

### Setting the limits

The ultrasonic sensor features two switching outputs with teachable switching ranges. The range is either set via Easy-Teach or via the buttons on the housing. The green and yellow LEDs indicate whether the sensor has detected the object.

Various functions such as single switchpoint, window mode or reflection mode to a fixed

## Mounting instructions

### Mounting instructions/Description

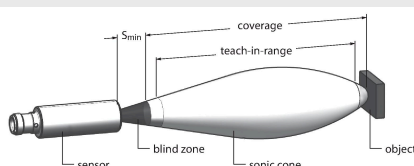

target can be taught. Further information is described in the operating instructions. How to set the window mode by teaching two limits is described below. These two limits form the switching window and can be selected freely within the detection range.

### Easy-Teach

- Connect the teach adapter TX1-Q20L60 between the sensor and connection cable
- Position object for the first limit value
- Press and hold the button to select output 1 or output 2 against Gnd for min. 2 or min. 8 seconds respectively
- Press and hold the button against Gnd for 8 to 13 seconds to teach the first limit value
- Position object for the second limit value
- Press and hold button against Gnd for at least 2 seconds

### Teach button

- Position object for the first limit value
- Press button 1 to select output 1 or output 2 for min. 2 or min. 8 seconds respectively
- Press and hold button 1 for 8 to 13 seconds
- Position object for the second limit value
- Press and hold button 1 for at least 2 seconds

After a successful teach-in, the sensor automatically runs in standard operating mode. Unsuccessful teach-in is signaled by the LED flashing slowly at a frequency of 5 Hz.

### LED response

Successful teaching is indicated by a fast flashing green LED. Thereafter, the sensor automatically runs in normal operating mode. Unsuccessful teaching is indicated by the LED flashing alternately green and yellow.

In normal operating mode, both LEDs signal the switching state of output 1 of the sensor.

- Green: object within the detection range but not in switching range
- Yellow: object within the switching range
- Off: object outside the detection range

## Accessories

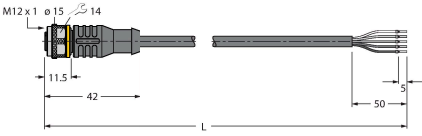
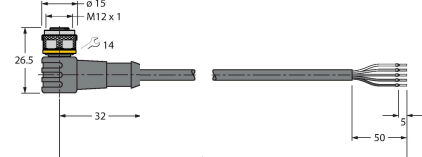
Dimension drawing	Type	ID	
	RKC4.5T-2/TEL	6625016	Connection cable, M12 female connector, straight, 5-pin, cable length: 2 m, jacket material: PVC, black; cULus approval
	WKC4.5T-2/TEL	6625028	Connection cable, M12 female connector, angled, 5-pin, cable length: 2 m, jacket material: PVC, black; cULus approval

## Accessories

Dimension drawing

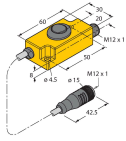

Type

TX1-Q20L60

ID

6967114

Teach adapter for inductive encoders, linear position, angle, ultrasonic and capacitive sensors