

RU100L-M18MS-UP8X2-H1151

Ultrasonic Sensor – Retroreflective Sensor

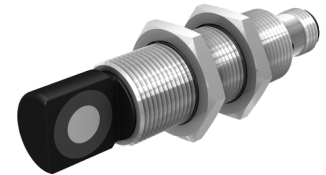
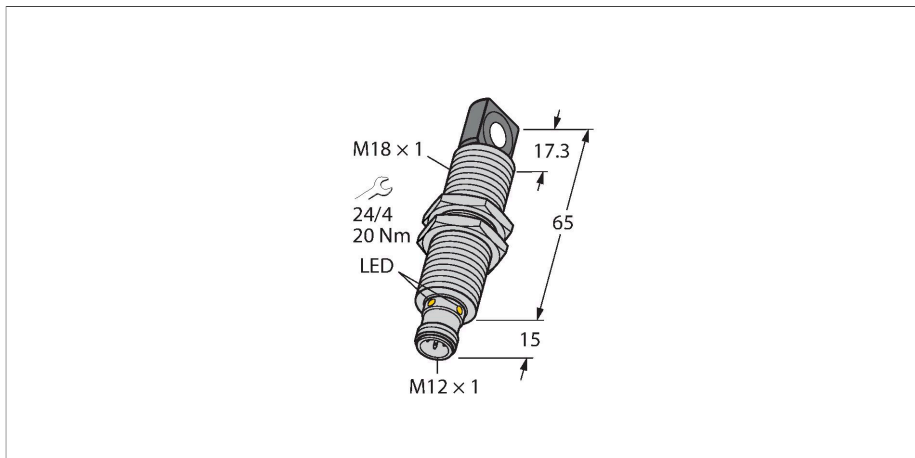

Technical data

Type	RU100L-M18MS-UP8X2-H1151
ID	1610079
Ultrasonic data	
Function	Retroreflective Sensor
Range	150...1000 mm
Minimum switching range	10 mm
Ultrasound frequency	200 kHz
Repeat accuracy	≤ 0.15 % of full scale
Temperature drift	± 1.5 % of full scale
Linearity error	≤ ± 0.5 %
Edge lengths of the nominal actuator	100 mm
Approach speed	≤ 8 m/s
Pass speed	≤ 2 m/s
Electrical data	
Operating voltage	15...30 VDC
Residual ripple	10 % U _{ss}
DC rated operational current	≤ 150 mA
No-load current	≤ 50 mA
Load resistance	≤ 1000 Ω
Residual current	≤ 0.1 mA
Response time typical	< 90 ms
Readiness delay	≤ 300 ms
Output function	NO/NC, PNP
Output 1	Switching output
Switching frequency	≤ 6.9 Hz
Hysteresis	≤ 10 mm
Voltage drop at I _a	≤ 2.5 V

Features

- Rectangular transducer front
- Cylindrical housing M18, potted
- Connection via M12 x 1 male
- Temperature compensation
- Teach-in range: 15...98 cm
- Resolution: 1 mm
- Aperture angle of sonic cone: ±16 °
- 1 x switching output, PNP
- Configurable via Teach-In
- Parameterizable NO/NC

Wiring diagram

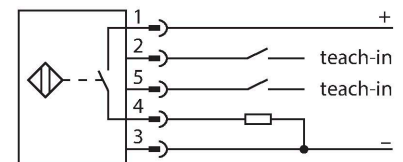

Functional principle

Ultrasonic sensors capture a multitude of objects contactlessly and wear-free with ultrasonic waves. It does not matter whether the object is transparent or opaque, metallic or non-metallic, firm, liquid or powdery. Even environmental conditions such as spray, dust or rain hardly affect their function.

The sonic cone diagram indicates the detection range of the sensor. In accordance with standard EN 60947-5-2, quadratic targets in a range of sizes (20 × 20 mm, 100 × 100 mm) and a round rod with a diameter of 27 mm are used.

Important: The detection ranges for other targets may differ from those for standard targets due to the different reflection properties and geometries.

Technical data

Short-circuit protection	yes / Cyclic
Reverse polarity protection	yes
Wire breakage protection	yes
Setting option	Remote Teach
Mechanical data	
Design	Threaded barrel, M18
Radiation direction	side
Dimensions	Ø 18 x 80 mm
Housing material	Metal, CuZn, Nickel Plated
Max. tightening torque of housing nut	20 Nm
Transducer material	Plastic, Epoxyd resin and PU foam
Electrical connection	Connector, M12 × 1, 5-wire
Ambient temperature	-25...+70 °C
Storage temperature	-40...+80 °C
Pressure resistance	0.5...5 bar
Protection class	IP67
Switching state	LED, Yellow
Object detected	LED, Green
Tests/approvals	
MTTF	281 years acc. to SN 29500 (Ed. 99) 40 °C
Declaration of conformity EN ISO/IEC	EN 60947-5-2
Vibration resistance	IEC 60068-2
Approvals	CE cULus

Sonic Cone

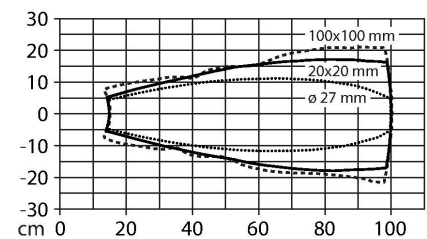

Mounting instructions

Mounting instructions/Description

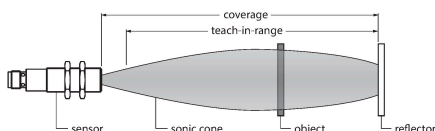

Teaching the reflector position

The ultrasonic sensor features a switching output with a teachable switching range. The green and yellow LEDs indicate whether the sensor has detected the object.

A switching range is taught in. This must be within the detection range. In this operating mode, the taught reflector position is detected permanently without an object.

Easy-Teach

- Connect the teach adapter TX1-Q20L60 between the sensor and connection cable
- Stationary reflector within the detection range
- Press and hold button for at least 2 s against Gnd

After a successful teach-in, the green LED flashes at 3 Hz and the sensor runs automatically in normal mode.

- To invert the output function, press and hold the button against the Ub for 2...7s

LED response

In standard operating mode, the two LEDs indicate the switching state of the sensor.

- Green: reflector within the detection range
- Yellow: object between the sensor and reflector

Accessories

MW-18

6945004

Mounting bracket for threaded barrel sensors; material: Stainless steel A2 1.4301 (AISI 304)

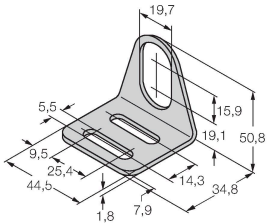

Accessories

Dimension drawing	Type	ID	
	RKC4.5T-2/TEL	6625016	Connection cable, M12 female connector, straight, 5-pin, cable length: 2 m, jacket material: PVC, black; cULus approval



WKC4.5T-2/TEL

6625028

Connection cable, M12 female connector, angled, 5-pin, cable length: 2 m, jacket material: PVC, black; cULus approval

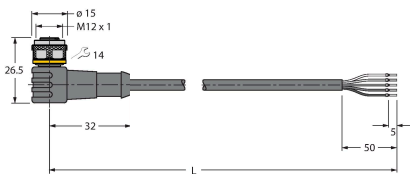

Accessories

Dimension drawing	Type	ID	
	TX1-Q20L60	6967114	Teach adapter for inductive encoders, linear position, angle, ultrasonic and capacitive sensors

