

SLLCR14-1050-S

Safety Technology – Safety Light Curtain

Cascadable Receiver

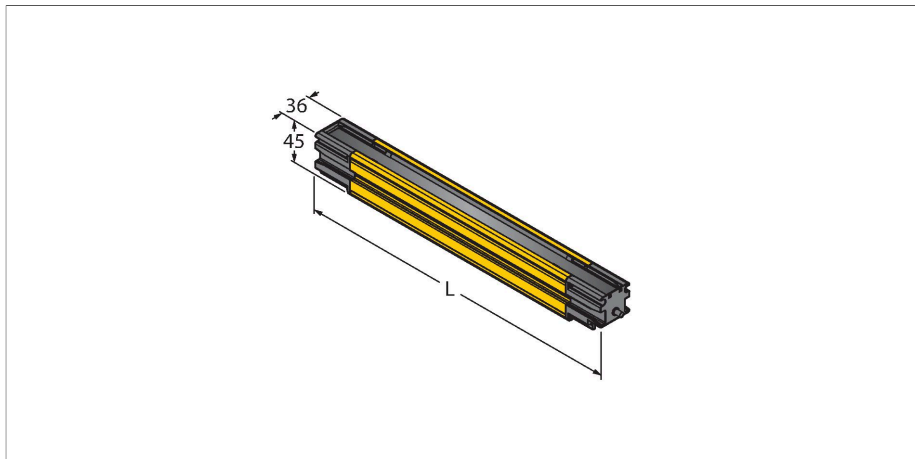

Technical data

Type	SLLCR14-1050-S
ID	3809042
Optical data	
Function	Light screen
Light type	IR
Optical resolution	14 mm
Range	100...12000 mm
Scan field	1050 mm
Number of beams	120
With muting function	no
Electrical data	
Operating voltage	20.4...27.6 VDC
DC rated operational current	≤ 121 mA
Max. current safe output	500 mA
Short-circuit protection	yes
Reverse polarity protection	yes
Output function	2 normally open contact, 2 × PNP
Voltage output	0...22.5 V
Current output	0 mA
Number of safe semiconductor outputs	2
Response time typical	< 30.3 ms
With restart interlock	yes
Blanking function	yes
Max. DC switching capacity	12 W
Mechanical data	
Design	Rectangular, EZ-Screen LS

Features

- Rugged housing
- Protection class IP67
- Diagnosis display for status and error indication
- Scan field L: 1050 mm
- Optical Alignment aid
- No blind zone
- Range: 0.1...12 m
- Resolution: 14 mm
- Operating voltage: 24 VDC
- Automatic cascade configuration
- No restart interlock
- Safety light curtain type 4 acc. to IEC 61496-1 and 61496-2
- Category 4 Ple acc. to EN ISO 13849-1
- SIL 3 acc. to IEC 61508 SIL 3 and CL3 acc. to IEC 62061
- Shock and vibration resistant acc. to IEC 61496-1
- The device is supplied without wiring or mounting brackets. Wiring and mounting brackets must be selected under connection or mounting accessories and are required to operate the device.

Wiring diagram

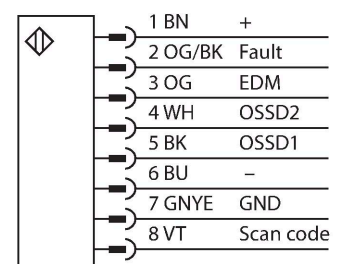

Technical data

Dimensions	45 x 36 x 1055 mm
Housing material	Metal, AL, Yellow
Lens	acrylic, Plastic
Cascadable	Yes
Electrical connection	Flat connector
Ambient temperature	-20...+55 °C
Protection class	IP67
Power-on indication	LED, Yellow
Switching state	LED, Red
Error indication	LED, red
Tests/approvals	
Approvals	CE, cULus, PL e acc. to EN ISO 13849-1:2008, SIL 3 acc. to IEC 61508

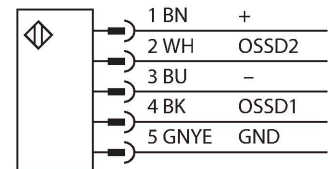
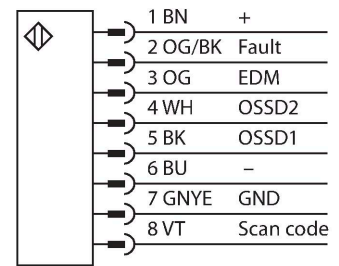

Functional principle

The self-monitoring safety light screens with redundant switching outputs are available in lengths up to 1.8 m and resolutions of 14, 23 or 40 mm. The devices are available individually or in pairs and are synchronized optically - a physical connection between transmitter and receiver is not necessary. For versions with cascading no further configuration is necessary. The setting is made automatically. Up to 4 couples of any length and resolution can be connected together. The dual scan of each receiver provides immunity against EMI, radio wave, ambient or strobe lights and welding sparks. All recipients have no restart interlock – an automatic reset is performed. If required individual beams can be hidden. The robust and sealed housing is ideally suited for industrial use. Status and error code can be read out in case of need via the diagnostic display. For easy mounting, LEDs indicate the proper alignment of each segment.

Accessories

EZLSA-MBK-16 Kein Maßbild vorhanden/ No dimension drawing available	3088559 Mounting bracket, black, die-cast zinc, for side mounting of an LS light screen
EZLSA-MBK-12 Kein Maßbild vorhanden/ No dimension drawing available	3090989 Mounting bracket, black, die-cast zinc, for central mounting of LS light screens larger than 980 mm
RDLS-815D Kein Maßbild vorhanden/ No dimension drawing available	3093156 Connection cable, 8-pin, open end, PVC, yellow, length: 4.57 m, RD male connector for direct connection to LS light screen

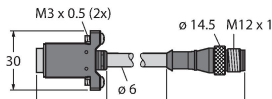
EZLSA-MBK-11 Kein Maßbild vorhanden/ No dimension drawing available	3087521 Mounting bracket, rotatable 360°, black, steel, for end mounting of an LS light screen
EZLSA-MBK-20 Kein Maßbild vorhanden/ No dimension drawing available	3093176 Mounting bracket, rotatable 360°, black, steel, universal mounting bracket for end mounting of an LS light screen
DELSE-81D 	3086942 Connection cable, 8-pin, M12 male connector, PVC, yellow, length: 0.31 m, RD male connector for direct connection to LS light screen

Accessories

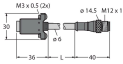
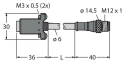
Dimension drawing	Type	ID	
 <p>M3 x 0.5 (D0) Ø 14.5 M12 x 1 30 0.5 40</p>	DELSE-51D	3086941	Connection cable, 5-pin, M12 male connector, PVC, yellow, length: 0.31 m, RD male connector for direct connection to LS light screen
 <p>M3 x 0.5 (D0) Ø 14.5 M12 x 1 30 0.5 40</p>	DELSE-81D	3086942	Connection cable, 8-pin, M12 male connector, PVC, yellow, length: 0.31 m, RD male connector for direct connection to LS light screen
<p>Kein Maßbild vorhanden/ No dimension drawing available</p>	RDLS-815D	3093156	Connection cable, 8-pin, open end, PVC, yellow, length: 4.57 m, RD male connector for direct connection to LS light screen
<p>Kein Maßbild vorhanden/ No dimension drawing available</p>	RDLS-515D	3801010	Connection cable, 5-pin, open end, PVC, yellow, length: 4.57 m, RD male connector for direct connection to LS light screen