

# PSG3M-3/TEY

## Actuator and Sensor Cable, PVC – Connection Cable

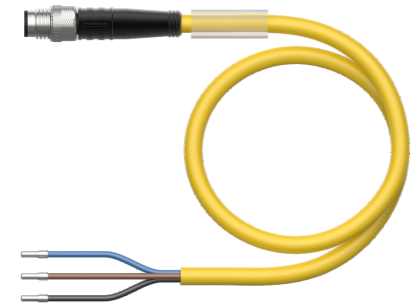
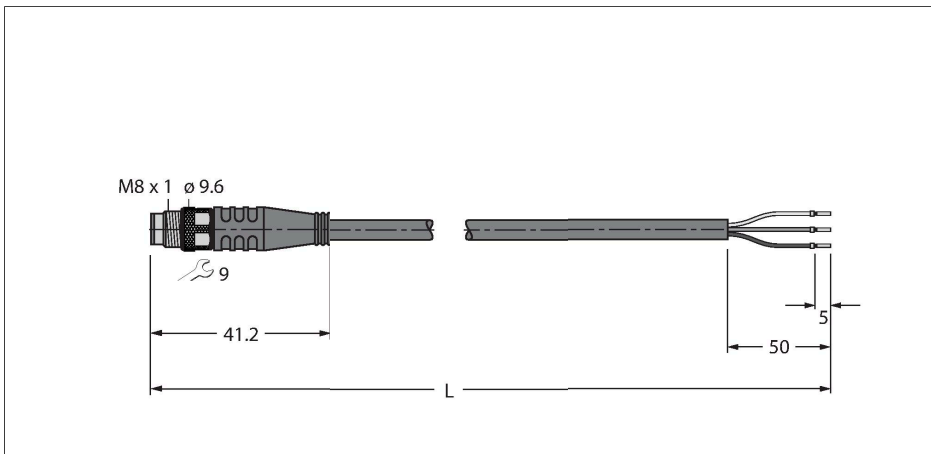

### Technical data

Type	PSG3M-3/TEY
ID	6629311
Connector A	Male, M8 × 1, Straight
Number of pins	3
Contacts	Brass, CuZn, Gold-plated
Contact carriers	Plastic, TPU, Black
Connector body	Plastic, TPU, Black
Coupling nut/screw	Brass, CuZn, Nickel-plated
Tightening torque (range)	0.5 ... 0.6 Nm (observe max. torque of mating connector!)
Mechanical lifespan	> 100 Mating cycles
Pollution degree	3
Protection class	IP67, IP69K, Only in screwed condition
Cable	
Cable diameter	Ø 4.3 mm ±0.20
Cable length	3 m
Cable jacket	PVC, Yellow
Core insulation	PVC
Core cross-section	3 x 0.34 mm <sup>2</sup>
Arrangement of strands	42 x 0.1 mm
Core colors	BN, BU, BK
Electrical properties at +20 °C	
Rated voltage	50 V <sub>AC</sub> /60 V <sub>DC</sub>
Test voltage	2000 V
Current	4 A
Insulation resistance	> 30.5 MΩ/km
forward resistance	max. 57 Ω/km

### Features



- Male M8, straight, 3-pin
- Jacket material: PVC
- Jacket color: yellow
- Resistant to chemicals and oils
- Flame retardant
- Resistant to acids and alkaline solutions
- Resistant to microbes and hydrolysis
- LABS free
- Protection class: IP67, IP69K
- Cable length: 3 m

### Cable Cross-Section

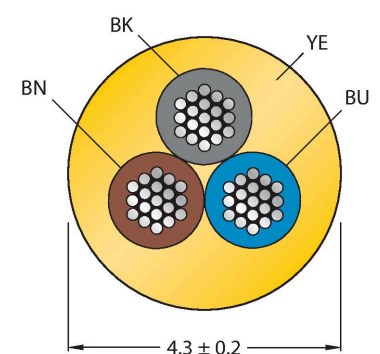

### Contact assignment



## Technical data

### Mechanical and chemical properties

Bending radius (stationary installation)	$\geq 5 \times \varnothing$
Bending radius (flexible use)	$\geq 10 \times \varnothing$
Ambient temperature (fixed)	-40...+105 °C
Ambient temperature (mobile)	-5...+80 °C
Approvals	cULus

## Functional principle

Drawing shows design status including hexagon coupling nut (Production start CW11/2016).

## Circuit Diagram



## Accessories

### TORQUE-WRENCH-SET-AS

6936170

Torque wrench set; handles with adjustable torque 0.4-1.0 Nm, torque wrench for M8 (SW9), fork wrench for M12 (SW 14)

### BLANK-LABEL-FOR-CORDSETS-TEL-TXL

6936206

Label for TEL and TXL cables, length: 18 mm, height: 4 mm, material: polycarbonate (PC), color: white, halogen-free and flame-retardant

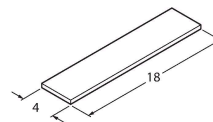

### HA5131-0

6905404

Field-wireable female connector, M8 × 1, straight, 3-pin, insulation piercing connection, cable feedthrough 2.5 to 5.1 mm, core cross-section/terminal capacity 0.14 to 0.34 mm<sup>2</sup>, plastic housing, metal nut

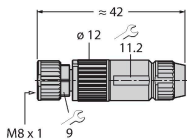

### B5133-0

6901030

Field-wireable female connector, M8 × 1, straight, 3-pin, screw terminal connection, cable feedthrough 3.5 to 5.0 mm, core cross-section/terminal capacity 0.14 to 0.50 mm<sup>2</sup>, plastic housing, metal nut

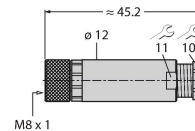

### H5131-0

6902700

Field-wireable female connector, M8 × 1, straight, 3-pin, pressfit technology, cable feedthrough 4.0 to 5.0 mm, core cross-section/terminal capacity 0.14 to 0.34 mm<sup>2</sup>, plastic housing, metal nut

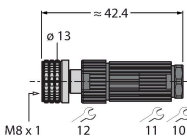

### H5231-0

6902800

Field-wireable female connector, M8 × 1, angled, 3-pin, pressfit technology, cable feedthrough 4.0 to 5.0 mm, core cross-section/terminal capacity 0.14 to 0.34 mm<sup>2</sup>, plastic housing, metal nut

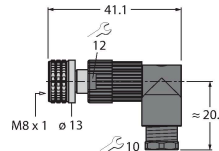

FW-PRKPM0320-SA-S-0406

10002292

Field-wireable female connector, M8 × 1, straight, 3-pin, screw terminal connection, cable feedthrough 4.0 to 5.5 mm, core cross-section/terminal capacity 0.14 to 0.5 mm<sup>2</sup>, plastic housing, metal coupling nut

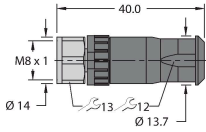

## Accessories

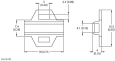
Dimension drawing	Type	ID	
	LABEL-HOLDER-FLEX-PVC	100048170	PVC label holder for identification of extension cables (TEL/TXL product series); for cable diameters: min. 5 mm; dimensions 4 × 18 mm; delivery unit: 50 pcs. per package