

TB-EM18WD-H1147-EX

HF Read/Write Head – For Explosion Hazardous Areas or Areas with Extreme Requirements (e.g. Food Industry)

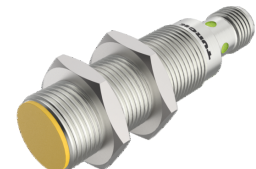
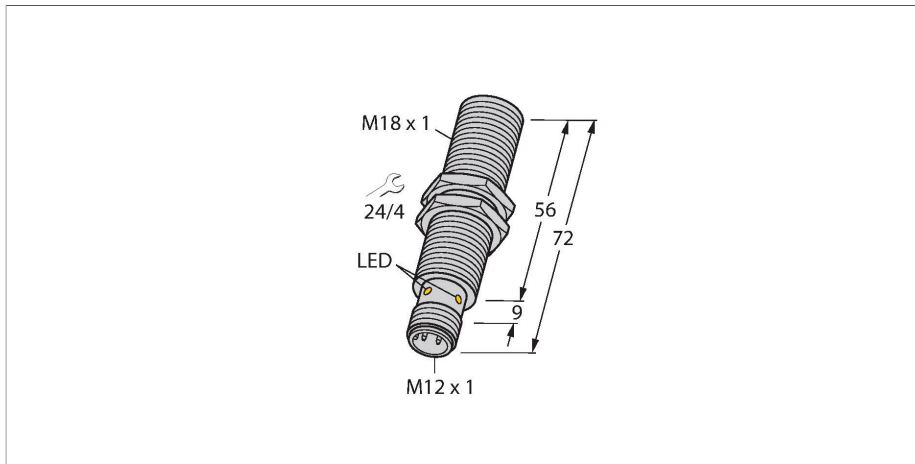

Technical data

Type	TB-EM18WD-H1147-EX
ID	7030381
Approvals	CE UKCA UL FDA ATEX
Radio approvals	EU/RED: Europe UK SI 2017/1206: United Kingdom FCC: USA IC: Canada MIC: Japan
Device marking	Ⓔ II 3G Ex ec IIC T4 Gc II 3D Ex tc IIIB T135°C Dc
Approval acc. to	TURCK Ex-10005M X
Electrical data	
Operating voltage	10...30 VDC
DC rated operational current	≤ 80 mA
inrush current	700 mA For: 1 ms
Data transfer	Inductive coupling
Technology	HF RFID
Operating frequency	13.56 MHz
Radio communication and protocol standards	ISO 15693 NFC Typ 5
Read/Write distance max.	30 mm
Output function	4-wire, Read/Write
Mechanical data	
Mounting conditions	Flush
Ambient temperature	-25...+70 °C
	For explosion hazardous areas see instruction leaflet

Features

- Threaded barrel, M18 x 1
- Stainless steel, 1.4404
- Front cap made of liquid crystal polymer
- High protection class IP69K, for harsh environments
- Special double-lip seal
- Protection against all common acid and alkaline cleaning agents
- For the food industry
- Laser engraved label, permanently legible
- Powered and operated only via connection to BL ident interface module
- M12 × 1 connector, connection only via BL ident extension cable
- ATEX category II 3 G, Ex zone 2
- ATEX category II 3 D, Ex zone 22

.../S2503 Connectors

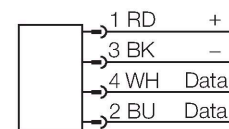

.../S2500 Connectors

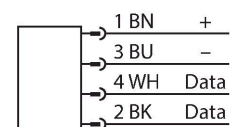

.../S2501 Connectors

Technical data

Design	Threaded barrel, M18 x 1
Dimensions	72 mm
Housing diameter	Ø 18 mm
Housing material	Stainless steel, 1.4404 (AISI 316L)
Active area material	Plastic, LCP
Vibration resistance	55 Hz (1 mm)
Shock resistance	30 g (11 ms)
Protection class	IP68 IP69K
Electrical connection	M12 x 1
MTTF	391 years acc. to SN 29500 (Ed. 99) 20 °C
Power-on indication	LED, Green
Included in delivery	SC-M12/3GD
Packaging unit	1

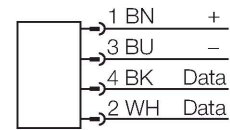

Functional principle

The HF read/write devices operating at a frequency of 13.56 MHz form a transmission zone, the size of which (0...500 mm) varies depending on the combination of read/write device and tag used.

The read/write distances mentioned here only represent standard values measured under laboratory conditions, free from any influences caused by surrounding materials.

The read/write distances of the tags for mounting in metal TW-R**-M(MF) were determined in metal.

Attainable distances may vary by up to 30 % due to component tolerances, mounting conditions, ambient conditions and material qualities (especially when mounted in metal). Testing of the application under real operating conditions is therefore essential, especially with on-the-fly reading and writing!

Mounting instructions/Description

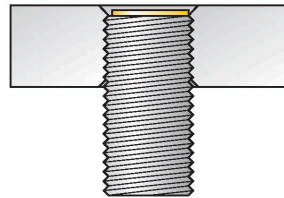

Diameter active area B Ø 18 mm

Width active area B 18 mm

flush mounting

LED	Color	Status	Meaning
1	OFF	OFF	Operating voltage switched off
	GREEN	ON	Operating voltage switched on
	GREEN	FLASHING (1 Hz)	HF field switched off
	GREEN	FLASHING (2 Hz)	Tag in detection range

Dimensions	Type designation	Read-write distance		Transfer zone		Minimum distance between two read-write heads [mm]
		Recommended (mm)	max. [mm]	length max. [mm]	width offset max. [mm]	
	IN TAG 200 SLIX2 100037960	8	15	12	6	54
	IN TAG 200 2K FRAM 100002358	5	12	16	8	54

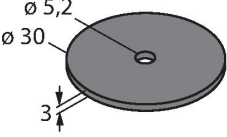
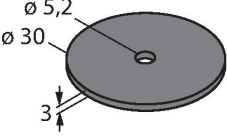
	IN TAG 300 SLIX2 100002356	8	17	22	11	54
	IN TAG 300 2K FRAM 100002359	6	14	18	9	54

Accessories

MW-18

6945004

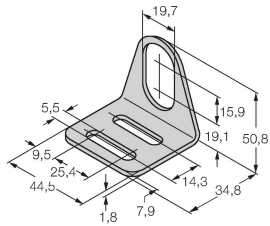

Mounting bracket for threaded barrel sensors; material: Stainless steel A2 1.4301 (AISI 304)

BSS-18

6901320

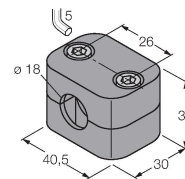

Mounting clamp for smooth and threaded barrel sensors; material: Polypropylene

PN-M18

6905310

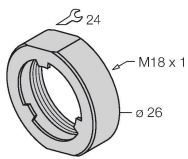

Protective nut for M18 x 1 threaded barrels; material: Stainless steel A2 1.4305 (AISI 303)