

Accesorii

Suport de montare

MW-08

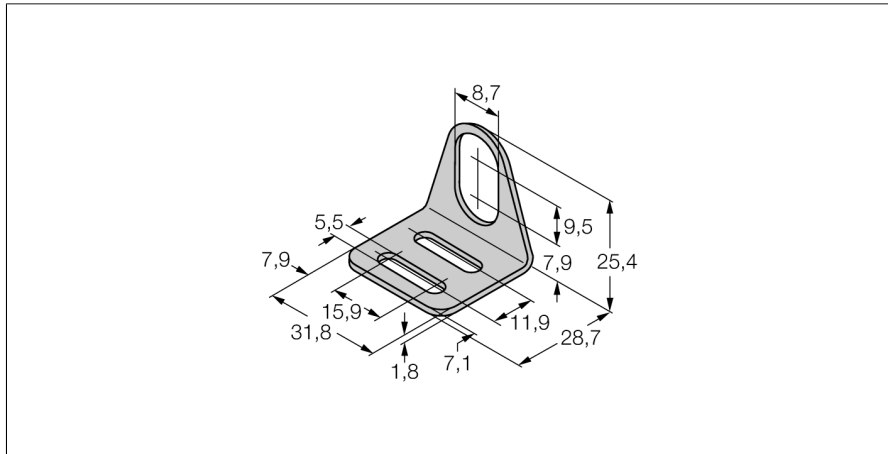

- Suport de montare pentru senzori cilindrici filetați M18 x1
- oțel inoxidabil A2 1.4301 (AISI 304)

Descriere generală

The mounting bracket for the sensor in the threaded barrel M8 x1 provides high flexibility for mounting. The position of the sensor can easily be re-adjusted in all directions and is thus very user friendly.

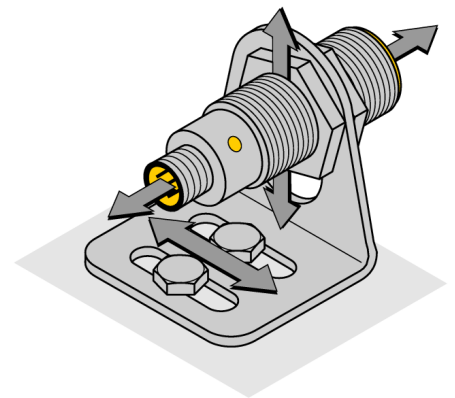

Tip	MW-08
Nr. ID	6945008
Design	Accesorii pentru cilindri filetați, M8
Dimensiuni	28.7 x 31.8 x 25.4mm
Materialul carcasei	Metal, 1.4301 (AISI 304)